

KSJ 属于常开型直流输出固体继电器，面板安装，控制电压 4-32VDC，负载电压 30VDC-1200VDC（其中 30VDC-200VDC 采用 MOSFET 输出，400VDC-1200VDC 采用 IGBT 输出），负载电流 7A-100A，输入和输出之间光电隔离，介质耐压为 2500Vrms。



- ◆ MOSFET 或 IGBT 输出
- ◆ 低阻抗
- ◆ 控制电压 :4-32VDC
- ◆ 内置过压保护器件
- ◆ 光电隔离,介质耐压 :2500Vrms
- ◆ 面板安装
- ◆ LED 指示
- ◆ 符合 RoHS

产品选型 ▶

KSJ	50	D	40	-L	(XXX)
KSJ系列 (1)	负载电压 30:30VDC 50:50VDC 60:60VDC 100:100VDC 200:200VDC 400:400VDC 600:600VDC 1200:1200VDC	直流控制	负载电流 7:7Amp 10:10Amp 20:20Amp 25:25Amp 40:40Amp 50:50Amp 80:80Amp 100:100Amp	LED指示灯	客户代码

(1) 具体型号以下表罗列为准

描述	30VDC	50VDC	60VDC	100VDC	200VDC	400VDC	600VDC	1200VDC
7A			KSJ60D7-L					
10A					KSJ200D10-L			
20A				KSJ100D20-L	KSJ200D20-L			
25A						KSJ400D25-L	KSJ600D25-L	KSJ1200D25-L
40A		KSJ50D40-L		KSJ100D40-L	KSJ200D40-L			
50A	KSJ30D50-L		KSJ60D50-L				KSJ600D50-L	KSJ1200D50-L
80A		KSJ50D80-L		KSJ100D80-L				
100A	KSJ30D100-L			KSJ100D100-L				

输入参数 (Ta=25°C)	
控制电压范围	4-32VDC
确保导通电压	4VDC
确保关断电压	1VDC
最大控制电流	25mA @32VDC
最大反向电压	32VDC

技术参数

输出参数 (Ta=25°C)																		
	KSJ30D□-L		KSJ50D□-L		KSJ60D□-L		KSJ100D□-L			KSJ200D□-L			KSJ400D25-L		KSJ600D□-L		KSJ1200D□-L	
	50	100	40	80	7	50	20	40	80	100	10	20	40	25	25	50	25	50
负载电压范围 (VDC)	0-24		0-36		0-48		0-75			0-120			0-300		0-500		0-650	
最大负载电流 (A)	50	100	40	80	7	50	20	40	80	100	10	20	40	25	25	50	25	50
最大浪涌电流 (Apk,@10ms)	150	250	120	200	30	150	60	120	200	250	30	60	120	150	150	300	150	300
最大导通电阻 (mΩ)	4.2	2.1	12	6	14	7	13	13	6.5	6.5	60	30	30					
最大导通压降 (V)														1.75				
最大断态漏电流 (mA)	0.1												0.5					
最小负载电流 (mA)	2												2					
最大导通时间 (ms)	0.1												1					
最大关断时间 (ms)	0.1												1					

其它参数 (Ta=25°C)		
介质耐压[50Hz/60Hz]	输入/输出	2500Vrms
	输入,输出/底板	2500Vrms
绝缘电阻 (@500VDC)	1000MΩ	
工作温度范围	-30°C ~ +80°C	
储存温度范围	-30°C ~ +100°C	
重量(典型值)	100g	

应用场合

直流加热,直流电源,直流阀,直流马达,医疗设备等。

安装尺寸/接线图

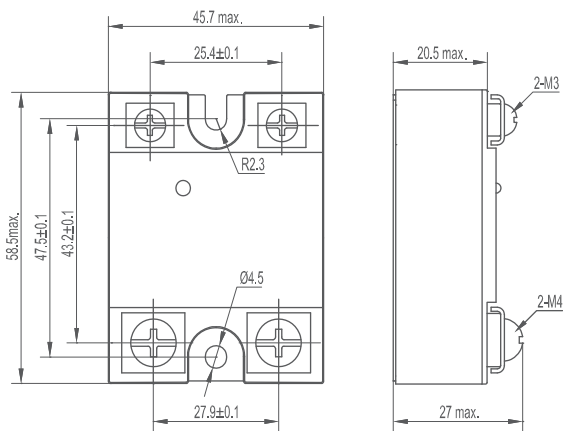

安装尺寸图

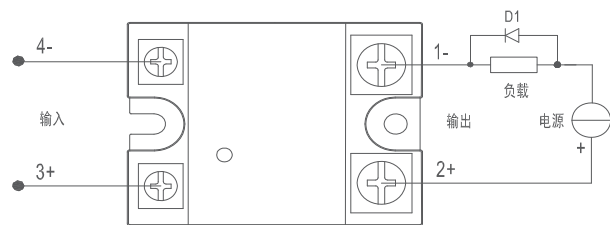

*当使用感性负载时必须加抑制电路,如图负载两端反并联续流二极管D1
D1: 快速恢复二极管

接线图

温度曲线 ▶

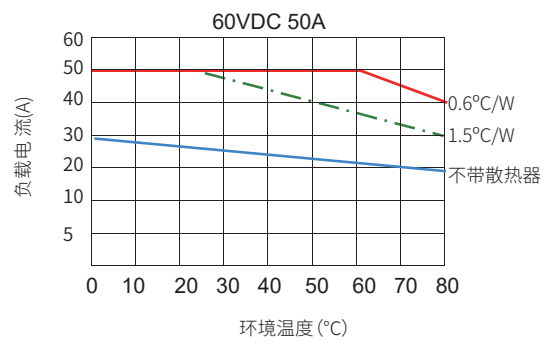
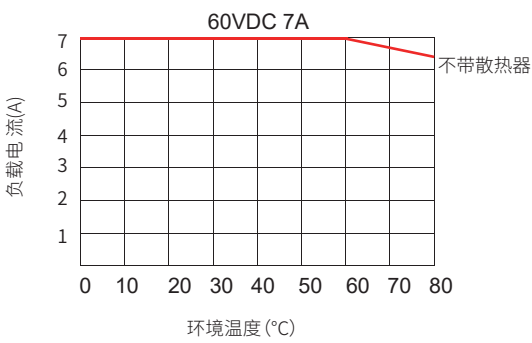
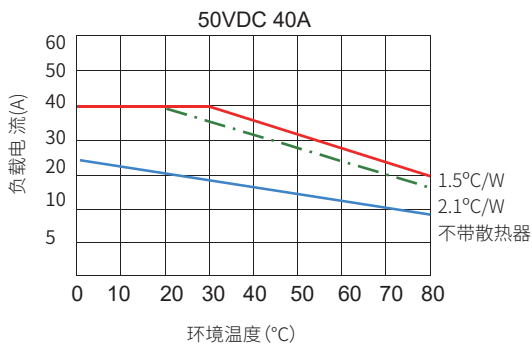
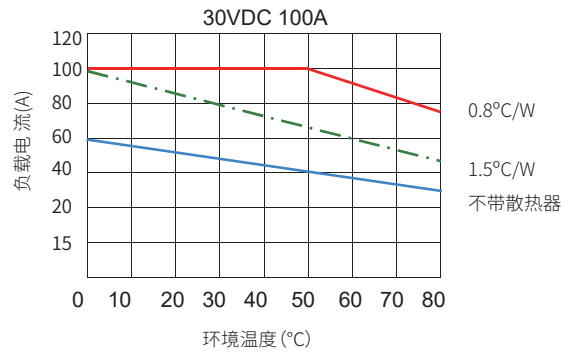
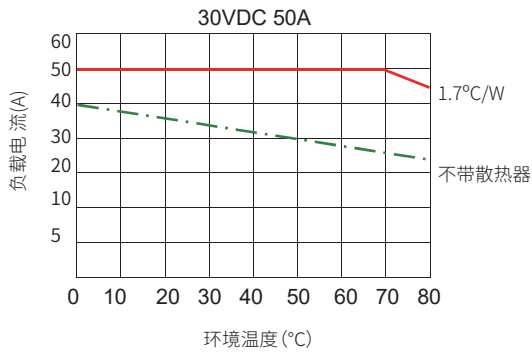

温度曲线 ▶

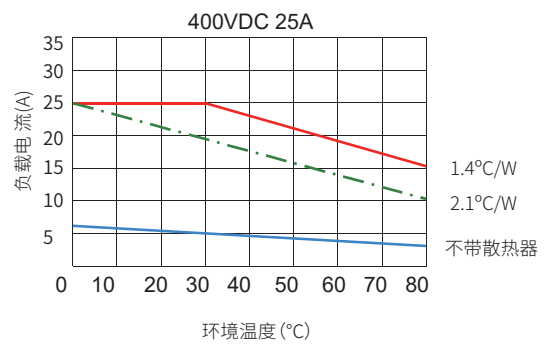
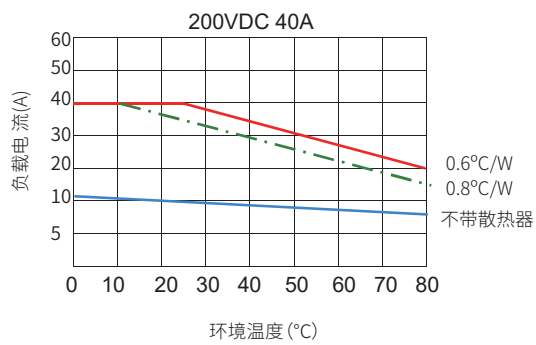
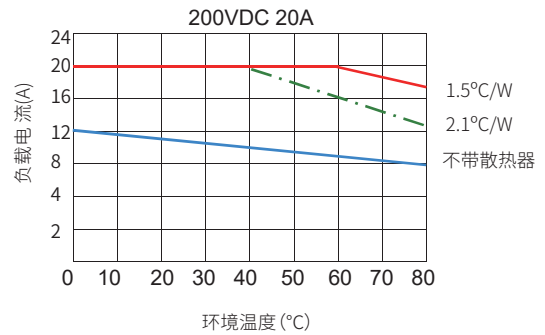
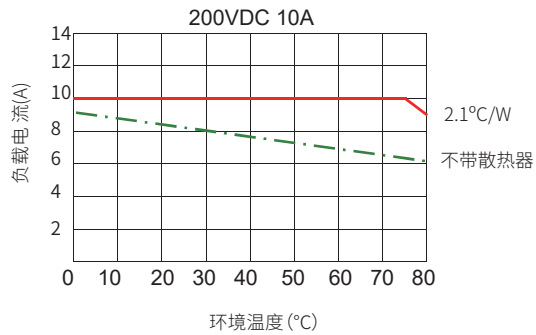
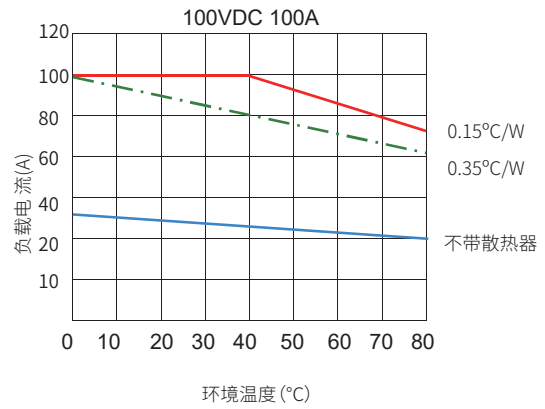
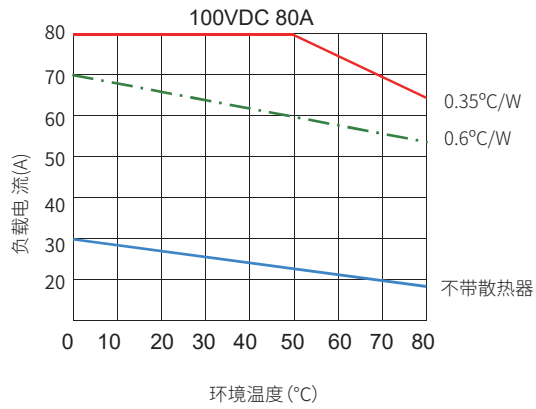
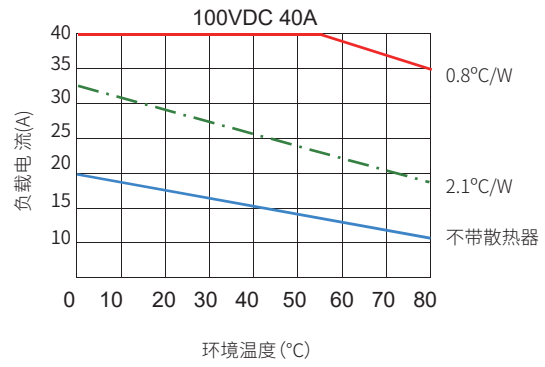
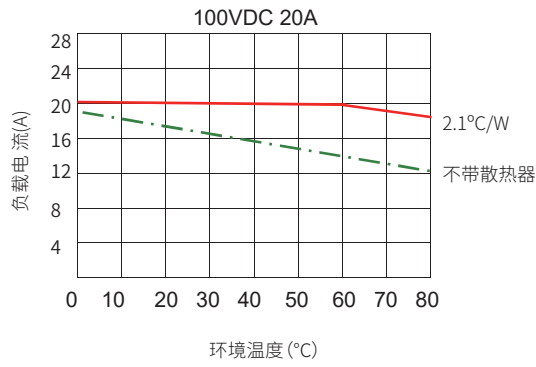

温度曲线 ▶

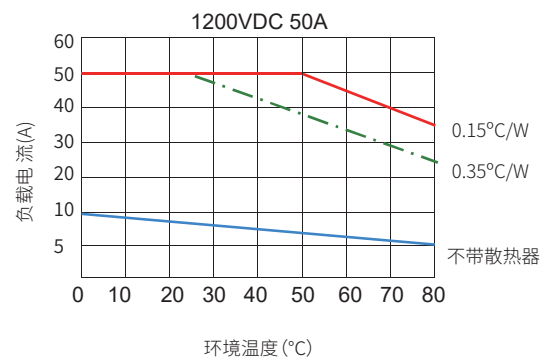
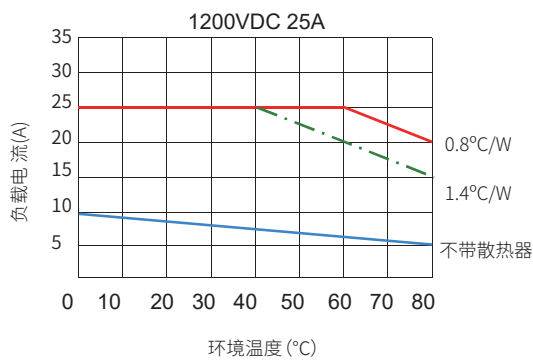
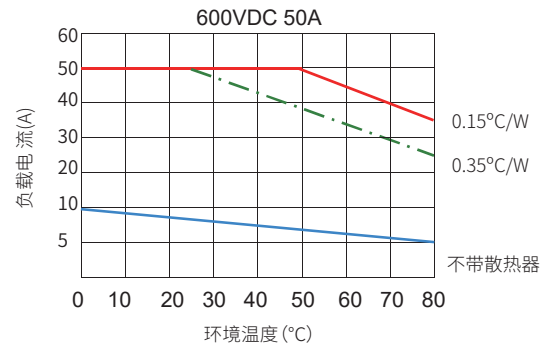
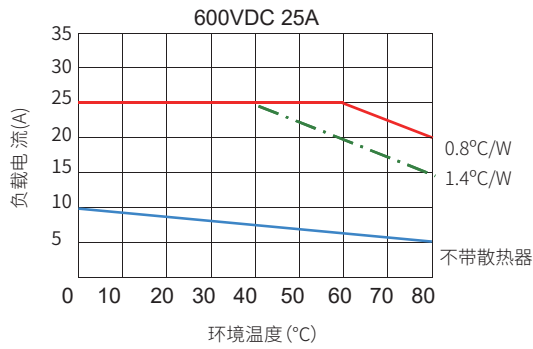

注意事项 ▶

1. 继电器工作产生的热量需通过底板散出, 需确保继电器底板与散热器接触紧密、安装牢靠, 且接触面需加导热垫片或涂覆导热硅脂。
2. 继电器端子应确保接线牢固, 接线松弛会导致产品异常发热, 损坏产品。输入端子的推荐安装扭矩为 (0.58~0.98) N·m, 输出端子的推荐安装扭矩为 (0.98~1.37) N·m。
3. 产品工作的环境温度较高时, 请参照温度曲线降额使用。
4. 容性负载在导通瞬间会产生极高的浪涌电流, 有可能会造成固体继电器因过大的浪涌电流而损坏。因此, 如果负载是容性负载, 或负载有并联大电容, 强烈建议在负载回路中串联NTC对浪涌电流进行抑制, 以免损坏产品。
5. 使用过程中特别注意静电防护

产品认证 ▶

