

产品描述 ▶

KSJ属于常开型直流输出固体继电器，面板安装，控制电压4-32VDC，负载电压30VDC-1200VDC（其中30VDC-200VDC采用MOSFET输出，400VDC-1200VDC采用IGBT输出），负载电流7A-100A，输入和输出之间光电隔离，介质耐压为2500Vrms。



- ◆ MOSFET 或 IGBT 输出
- ◆ 光电隔离, 介质耐压: 2500Vrms
- ◆ 低阻抗
- ◆ 面板安装
- ◆ 控制电压: 4-32VDC
- ◆ LED 指示
- ◆ 内置过压保护器件
- ◆ 符合 RoHS



产品选型 ▶

KSJ	50	D	40	-L	(XXX)
KSJ系列 (1)	负载电压 30:30VDC 50:50VDC 60:60VDC 100:100VDC 200:200VDC 400:400VDC 600:600VDC 1200:1200VDC	直流控制	负载电流 7:7Amp 10:10Amp 20:20Amp 25:25Amp 40:40Amp 50:50Amp 80:80Amp 100:100Amp	LED指示灯	客户代码

(1) 具体型号以下表罗列为准

描述	30VDC	50VDC	60VDC	100VDC	200VDC	400VDC	600VDC	1200VDC
7A			KSJ60D7-L					
10A					KSJ200D10-L			
20A				KSJ100D20-L	KSJ200D20-L			
25A						KSJ400D25-L	KSJ600D25-L	KSJ1200D25-L
40A		KSJ50D40-L		KSJ100D40-L	KSJ200D40-L			
50A	KSJ30D50-L		KSJ60D50-L				KSJ600D50-L	KSJ1200D50-L
80A		KSJ50D80-L		KSJ100D80-L				
100A	KSJ30D100-L							

输入参数 (Ta=25°C)	
控制电压范围	4-32VDC
确保导通电压	4VDC
确保关断电压	1VDC
最大控制电流	25mA @32VDC
最大反向电压	32VDC

技术参数 ▶

输出参数 (Ta=25°C)																	
规格型号	KSJ30D□-L		KSJ50D□-L		KSJ60D□-L		KSJ100D□-L			KSJ200D□-L			KSJ400D25-L	KSJ600D□-L		KSJ1200D□-L	
负载电流	50	100	40	80	7	50	20	40	80	10	20	40		25	50	25	50
负载电压范围 (VDC)	0-24		0-36		0-48		0-75			0-120			0-300	0-500		0-650	
最大负载电流 (A)	50	100	40	80	7	50	20	40	80	10	20	40	25	25	50	25	50
最大浪涌电流 (Apk,@10ms)	150	250	120	200	30	150	60	120	200	30	60	120	75	75	150	75	150
最大导通电阻 (mΩ)	4.2	2.1	12	6	14	7	13	13	6.5	60	30	30					
最大导通压降 (V)														1.75			
最大断态漏电流 (mA)							0.1							0.5			
最小负载电流 (mA)							2							2			
最大导通时间 (ms)							0.3							1			
最大关断时间 (ms)							0.3							1			

其它参数 (Ta=25°C)		
介质耐压 (50Hz/60Hz)	输入/输出	2500Vrms
	输入,输出/底板	2500Vrms
绝缘电阻 (@500VDC)	1000MΩ	
工作温度范围	-30°C ~ +80°C	
储存温度范围	-30°C ~ +100°C	
重量 (典型值)	100g	

应用场合 ▶

直流加热,直流电源,直流阀,直流马达,医疗设备等。

安装尺寸/接线图 ▶

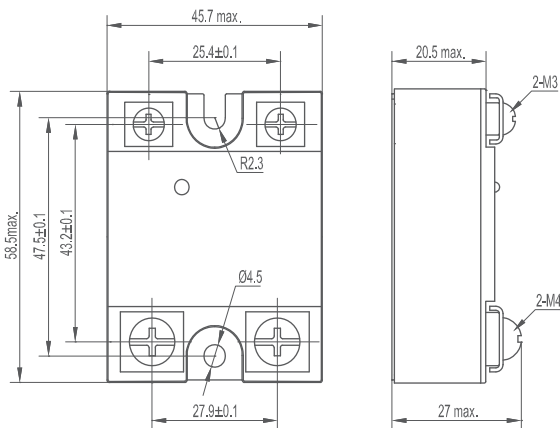

安装尺寸图

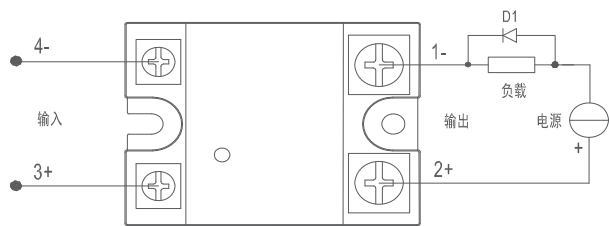

*当使用感性负载时必须加抑制电路,如图负载两端反并联续流二极管D1
D1:快速恢复二极管

接线图

温度曲线 ▶

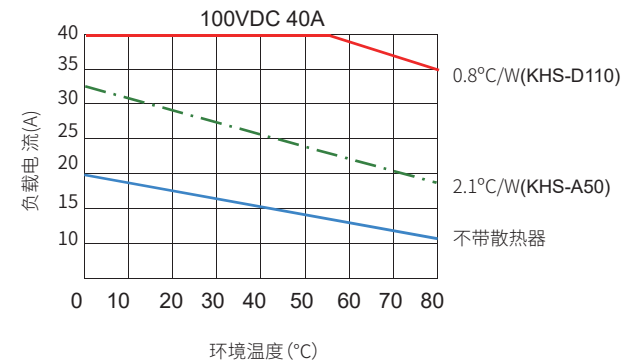
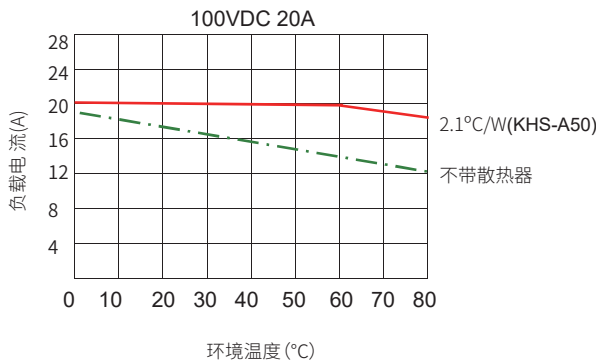
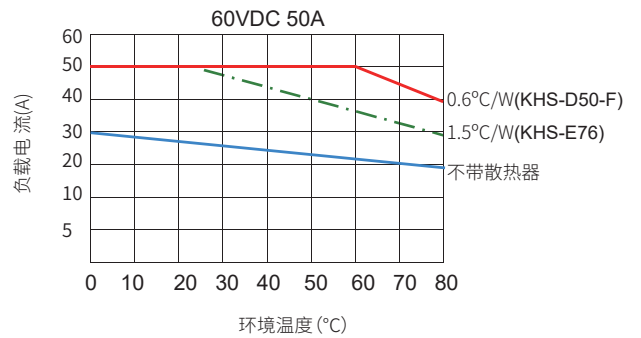
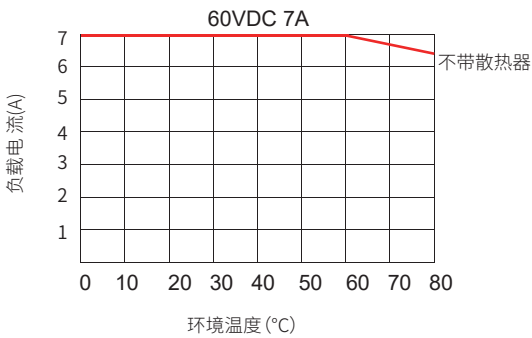
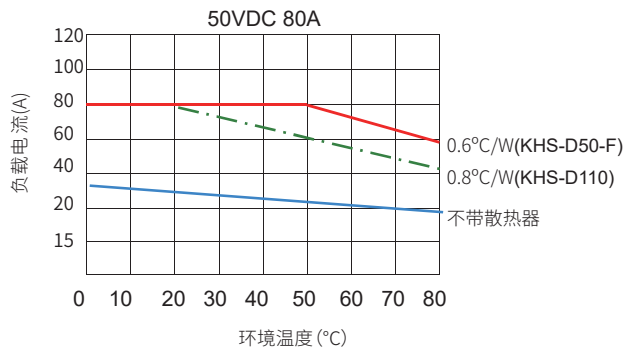
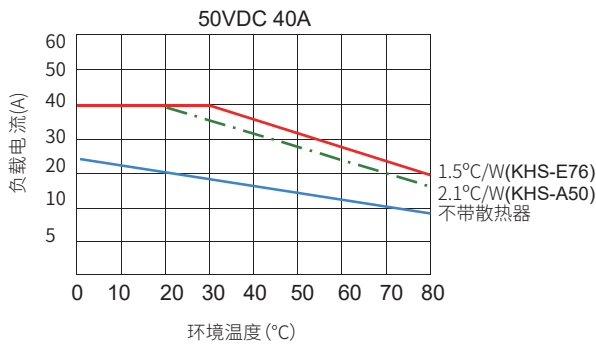
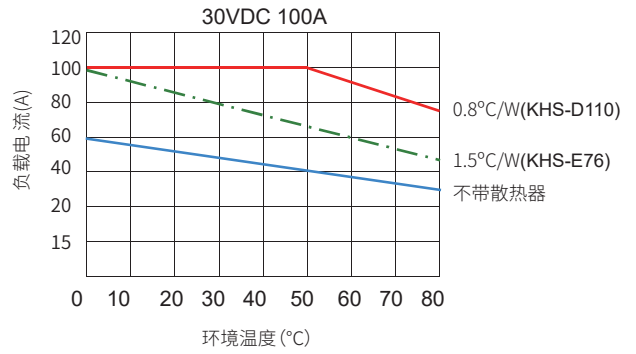
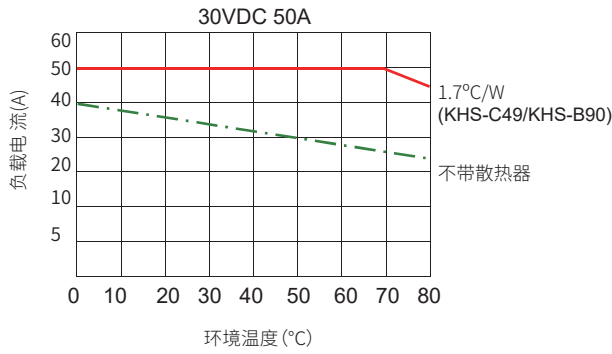

温度曲线 ▶

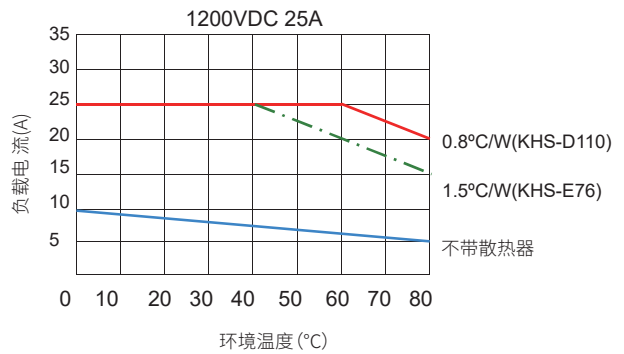
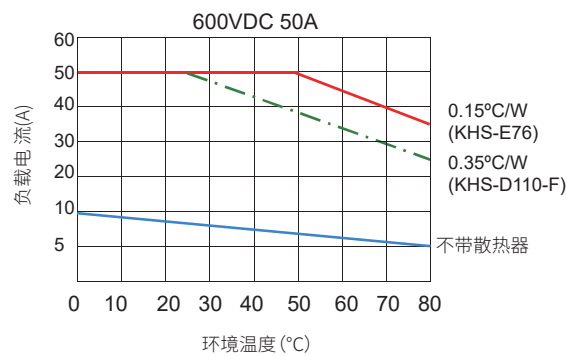
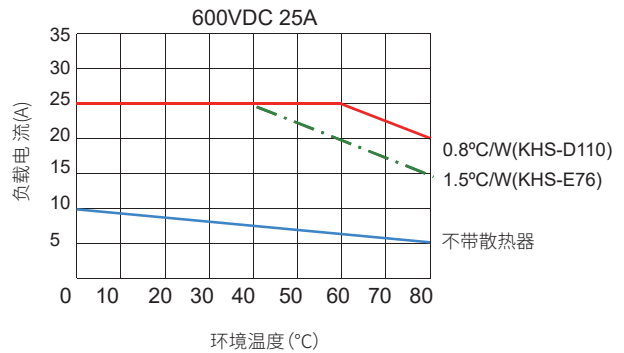
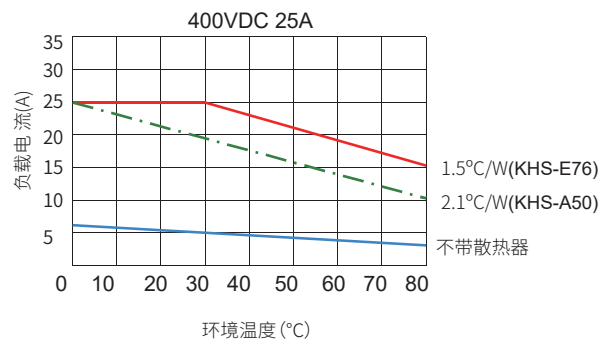
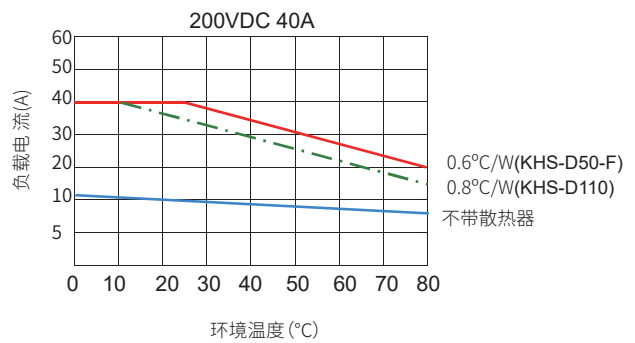
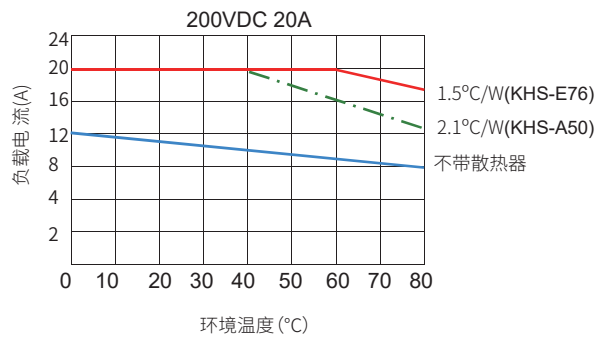
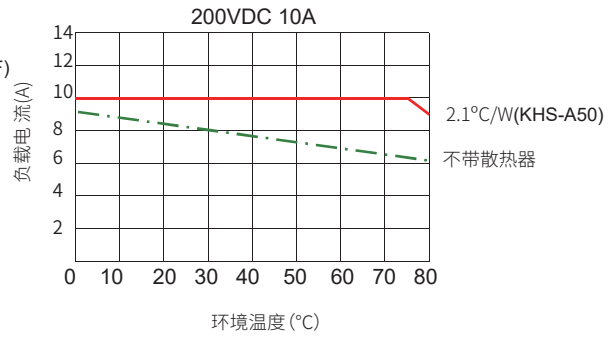
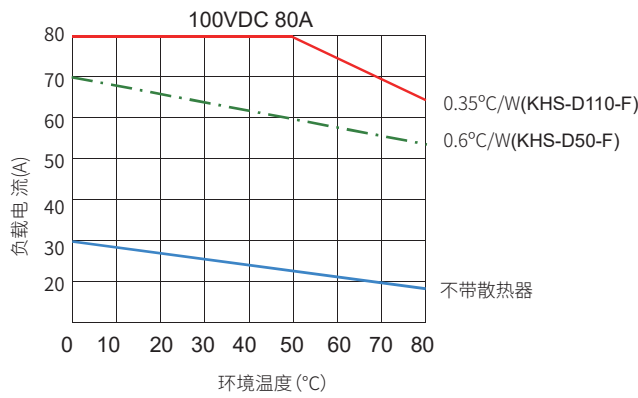

温度曲线 ▶

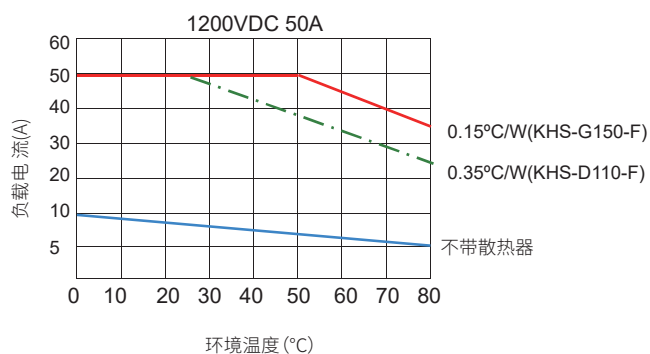

注意事项 ▶

1. 必须根据热曲线将继电器安装到适当大小的散热器上。在继电器和散热器之间必须使用热脂或热垫，其扭矩应降低至18-20/2.0-2.2 in-lb/N·m。
2. 当连接到SSR时，请确保正确地拧紧螺丝(输入13-15/1.5-1.7in/lb/N·m，输出18-20/2.0-2.2 in-lb/N·m)。
3. 环境温度在25°C以上时，见热降额曲线。
4. 容性负载再导通瞬间会产生极高的浪涌电流，有可能会造成导致固体继电器因过大的浪涌电流而损坏。因此，如果负载时容性负载，或负载有并联大电容，强烈建议在负载回路中串联NTC对浪涌电流进行抑制，以免损坏产品。