

产品描述 ▶

KWR系列是非隔离型调压模块，调节电位器150K/2W，220K/2W，470K/2W。由于其具备多种应用的性能，是最广泛使用的工业调压模块。输出电流为10~100A。

- ◆ 负载电流范围10A~100A
- ◆ 调节电位器150K/2W、220K/2W、470K/2W
- ◆ 带有安全保护盖(可选)
- ◆ LED指示
- ◆ 内置RC吸收回路



产品选型 ▶

KWR	480	F	40	-L
KWR系列	负载电压 480:480VAC	调节电位器规格 F:150K/2W G:220K/2W H:470K/2W	负载电流 10: 10Amp 25: 25Amp 40: 40Amp 60: 60Amp 80: 80Amp 100: 100Amp	L: LED 指示灯

KWR	10A	25A	40A	60A	80A	100A
F规格	KWR480F10-L	KWR480F25-L	KWR480F40-L	KWR480F60-L	KWR480F80-L	KWR480F100-L
G规格	KWR480G10-L	KWR480G25-L	KWR480G40-L	KWR480G60-L	KWR480G80-L	KWR480G100-L
H规格	KWR480H10-L	KWR480H25-L	KWR480H40-L	KWR480H60-L	KWR480H80-L	KWR480H100-L

技术参数 ▶

输入参数	
调节电位器规格	F 150K/2W G 220K/2W H 470K/2W

技术参数 ▶

输出参数		
输出电源电压范围	24-530VAC	
最大浪涌电流(@10ms)	10A	100A
	25A	250A
	40A	400A
	60A	600A
	80A	800A
	100A	1000A
最大 I^2t (@10ms)	10A	50A ² s
	25A	312A ² s
	40A	800A ² s
	60A	1800A ² s
	80A	3200A ² s
100A	500A ² s	
最大瞬态电压	1200Vpk	
最大断态漏电流(在额定电压下)	5mA	

其它参数		
介质耐压(50Hz/60Hz)	输入,输出/底板	2500Vrms
绝缘电阻(@500VDC)	1000MΩ	
工作温度范围	-30°C ~ +80°C	
储存温度范围	-30°C ~ +100°C	
重量[典型值]	10A/25A/40A/60A/80A	90g
	100A	150g

应用场合 ▶

各种温度调节装置、塑料成型机械、硫化机械等

安装尺寸图 ▶

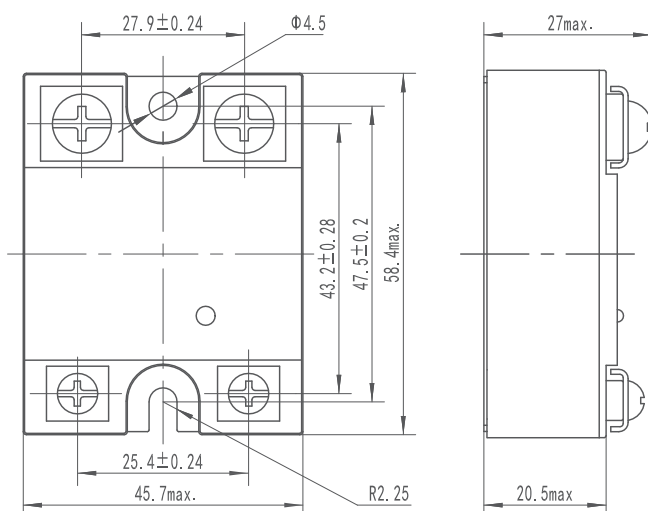

接线图 ▶

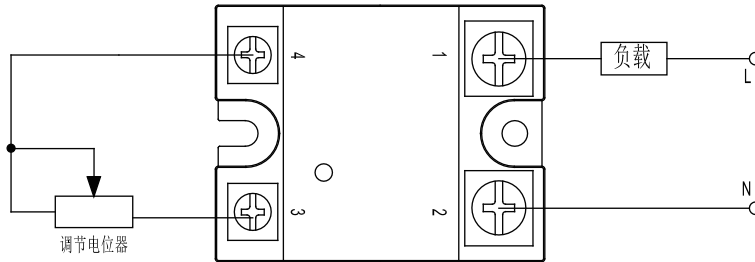

输出/比例控制特性 ▶

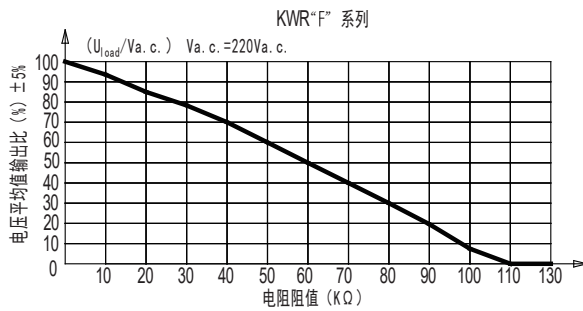
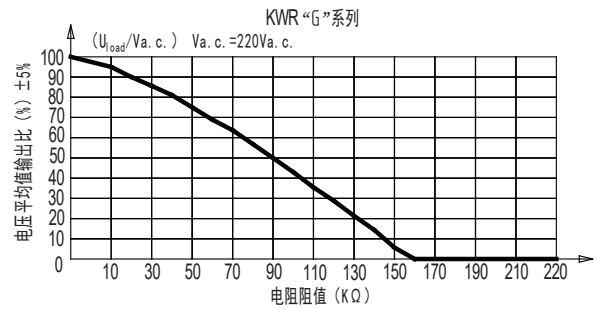
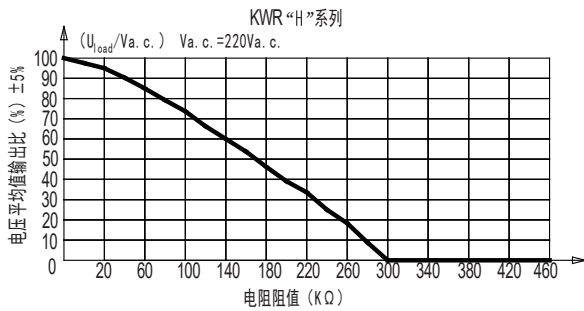

温度曲线 ▶

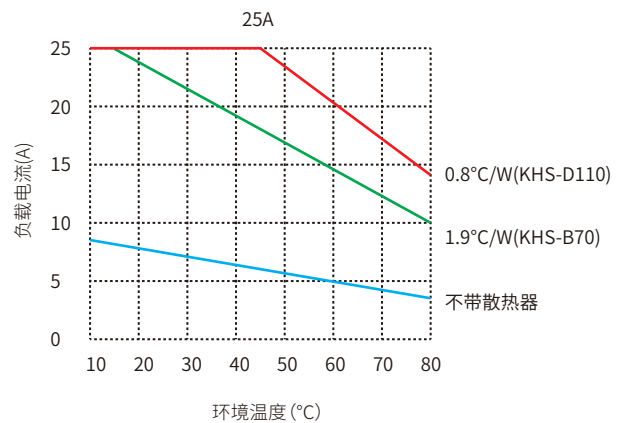
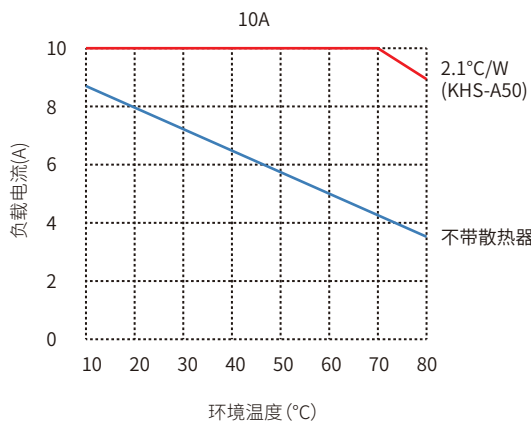

温度曲线 ▶

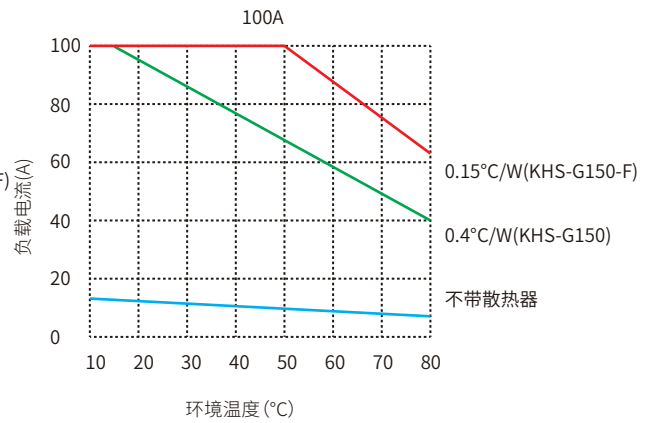
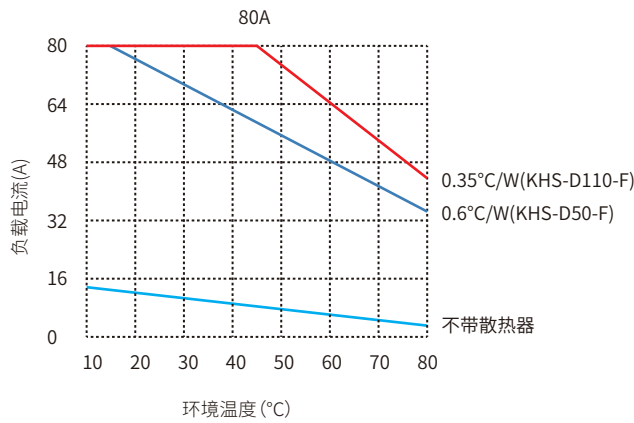
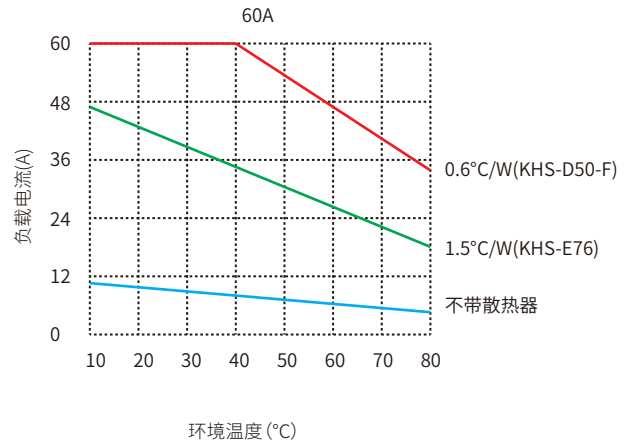
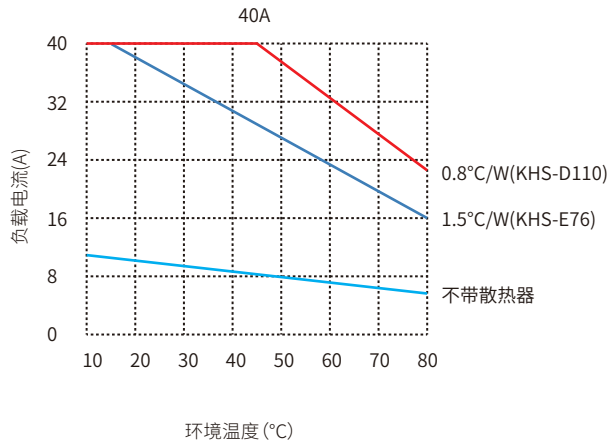

注意事项 ▶

1. 调压模块工作产生的热量需通过底板散出, 需确保调压模块底板与散热器接触紧密、安装牢靠, 且接触面需加导热垫片或涂覆导热硅脂。
2. 调压模块端子应确保接线牢固, 接线松弛会导致产品异常发热, 损坏产品。M3端子的推荐安装扭矩为 (0.58~0.98) N·m, M4端子的推荐安装扭矩为 (0.98~1.37) N·m。
3. 产品工作的环境温度较高时, 请参照温度曲线降额使用。