

CGT | 2020-2021

CATALOG FOR LED Light



Shenzhen CGT Technology Co.,Ltd



Company Profile

Established in 2010
Business Type: LED Lighting Products OEM/ODM
Factory: 100,000 square feet
Workforce: 150 people
R&D Team: 10 people
QC Team: 12 people
Product Certificate: TUV, ENEC, CB, CE, RoHs, SAA

E-mail: info@cgltled.com
TEL: 0086-755-22361751

Website: www.cgltled.com
<http://cglttech.en.alibaba.com/>

LED Industrial Lighting

LED High Bay Light

01-10



sBAY



gBAY



fBAY



HB-VE



oBAY



HB-U2



HB-U3



aBAY



HB-E



LHB-D

LED Flood Light & LED Stadium Spot Light

11-17



FL-F3



FLB



FL-C



FLH



FLA



HPA



HPB



HPM

LED Street Light

18-21



SLA



SLB



SLC



PKC

LED Tri-Proof Light

22-27



VPB



TPC

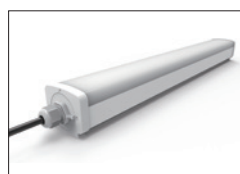

TPB



TPL-D



VPE

LED Commercial Lighting



TPE

LED Panel Light

28-37



BPL

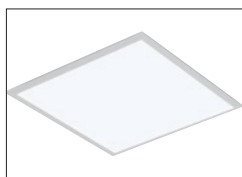

PL-F/H

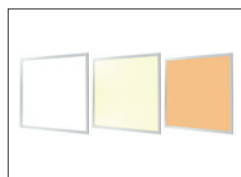

PL-CCT



PLW-S



PLW-R



PL-R/S



PLY

LED Ceiling Light & Down Light

38-41



CP



CLY



A6



A16



A22

LED Track Light

42-44



X16



C93&I93



Z92

LED Linear & Batten Light

45-49



LL-E



LL-A

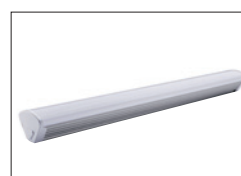

LL-H



LLC

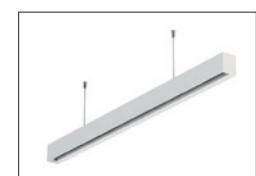

LLD

High Bay Light (sBay)



Power & 3CCT Selectable

FEATURES

- 2020 Private mold, unique design
- High Lumens Up to 150lm/w
- IP66 Wet Location
- Power and CCT selectable.
- Built-in Bi-Level Sensor
- High Quality driver
- 1-10V dimmable optional



BI-LEVEL SENSOR



Bi-level Sensor optional
Built-in Sensor
Max Height 15m(50ft)



High luminous Efficacy
Up to 140-160lm/w
DLC Premium
Lumileds (Philips) Chips
60°/90°/120° optional



Assemble Sensor Easily
Assemble or remove
Sensor Easily



Power and CCT Selectable
Easy to make inventory reserve
3-Power like 100W/120W/150W
3-CCT like 4000K-5000K-5700K

PARAMETER

MODEL NO.	POWER	VOLTAGE	BEAM ANGLE	LUMENS	CRI	Dimmable
HBS-100	80W/100W/120W	100-277Vac	60° 90° 120°	140lm/w @120W 145lm/w @100W 150lm/w @80W	80+	1-10V/Sensor
HBS-150	100W/120W/150W	100-277Vac	60° 90° 120°	140lm/w @150W 145lm/w @120W 150lm/w @ 100W	80+	1-10V/Sensor
HBS-200	150W/180W/200W	100-277Vac	60° 90° 120°	140lm/w @ 200W 145lm/w @ 180W 150lm/w @150W	80+	1-10V/Sensor
HBS-240	180W/200W/240W	100-277Vac	60° 90° 120°	140lm/w @ 240W 145lm/w @ 200W 150lm/w @180W	80+	1-10V/Sensor

LED High Bay (gBay)

Cost-Effective



Lens Version



Dome Cover Version

FEATURES

- Die-Casting Aluminum
- PC Lens or Dome Cover
- IP66 Wet Location
- 130lm/w, 160lm/w, 180lm/w optional
- 1-10V dimmable in standard
- Bi-level Sensor optional



BI-LEVEL SENSOR



Easy to assemble or separate the sensor

PARAMETER

MODEL NO.	POWER	VOLTAGE	BEAM ANGLE	LUMENS	Dimmable
HB-100G	100W	100-277vac	60° 90° 120°	140lm/w 160lm/w	1-10V/Sensor
HB-150G	150W	100-277vac	60° 90° 120°	140lm/w 160lm/w	1-10V/Sensor
HB-200G	200W	100-277vac	60° 90° 120°	140lm/w 160lm/w	1-10V/Sensor
HB-240G	240W	100-277vac	60° 90° 120°	140lm/w 160lm/w	1-10V/Sensor

LED High Bay(fBay)



PC Lens Version



Dome Cover Version

FEATURES



Good Heat Dissipation Body
Strong Aluminum Housing
with good Heat Dissipation.

High Quality Driver
1-10V dimmable
Surge protection 6KV

High efficient SMD LED chips
LM80 SMD LED & Luminous
Efficacy up to 140lm/w
CRI>90
120° Distribution

AVAILABLE OPTIONS



60° PC Reflector



Dome Style Frosted Lens

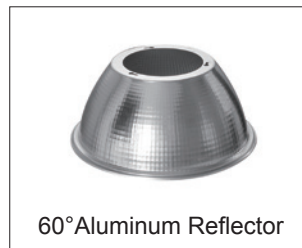

60° Aluminum Reflector



90° Aluminum Reflector

PARAMETER

MODEL NO.	POWER	VOLTAGE	BEAM ANGLE	Lumens	CRI	Dimmable
HB-100F2	100W	100-277Vac	60° 90° 120°	150lm/w	80+	1-10V/DALI
HB-150F2	150W	100-277Vac	60° 90° 120°	150lm/w	80+	1-10V/DALI
HB-200F2	200W	100-277Vac	60° 90° 120°	150lm/w	80+	1-10V/DALI
HB-240F2	240W	100-277Vac	60° 90° 120°	150lm/w	80+	1-10V/DALI
HB-300F2	300W	100-277Vac	60° 90° 120°	150lm/w	80+	1-10V/DALI

LED High Bay (HB-VE)



Tool-Free Assembling for Sensor In 5 Seconds

FEATURES

- IP66 Wet Location
- High efficacy, 140lm/w , CRI>80
- SCP/OVP/OTP protection driver, 90-350Vac
- 6KV/10KV surge protection
- 3 in 1 dimmable(PWM, 1-10V, Resistor) or microwave sensor



ADVANTAGE



Support Grouping Motion Sensor

Tool Free Assembling for Sensor In 5 Seconds



High Lumens
140lm/w CRI>80
Beam angle : 90° / 120°
190lm/w optional



Flicker Free Driver
SCP/OVP/OTP Protection
6KV/10KV Surge Protection
3 in 1 Dimmable(PWN, 1-10V, Resistor) Or Microwave Motion Sensor



Modular Design
LED modularity can be freely combination
Easy to Replace driver.
It is convenient to maintenance

PARAMETER

MODEL NO.	POWER	VOLTAGE	BEAM ANGLE	LUMENS	CRI	Dimmable
HB-40VE	40W	90-305Vac	90° / 120°	140lm/w 190lm/w	80+	1-10V/Sensor
HB-60VE	60W	90-305Vac	90° / 120°	140lm/w 190lm/w	80+	1-10V/Sensor
HB-100VE	100W	90-305Vac	90° / 120°	140lm/w 190lm/w	80+	1-10V/Sensor
HB-150VE	150W	90-305Vac	90° / 120°	140lm/w 190lm/w	80+	1-10V/Sensor
HB-200VE	200W	90-305Vac	90° / 120°	140lm/w 190lm/w	80+	1-10V/Sensor

FOOD LED High Bay (oBay)

IP69K For FOOD Industry



FEATURES

- NSF approval for food industries
- IP66 Smooth Body, make cleaning work easily
- IP69K hot steam scouring
- No Toxic Chemicals in Material
- No glass and no exposed screws



ADVANTAGE



NSF approval
for FOOD Industries



Seamless Design
Diminished dust and
easy to clean



Seamless Design
Diminished dust and
easy to clean



IP69K Hot Steam Scouring
Steam cleaning protection
of water pressure at 100
bar (1450 psi) /80°C

PARAMETER

MODEL NO.	POWER	VOLTAGE	BEAM ANGLE	LUMENS	CRI	Dimmable
HBO-100W	100W	100-277Vac	60° 90° 120°	140lm/w	80+	1-10V
HBO-150W	150W	100-277Vac	60° 90° 120°	140lm/w	80+	1-10V
HBO-200W	200W	100-277Vac	60° 90° 120°	140lm/w	80+	1-10V
HBO-240W	240W	100-277Vac	60° 90° 120°	140lm/w	80+	1-10V

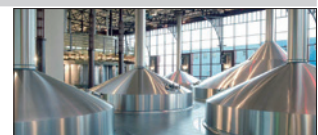
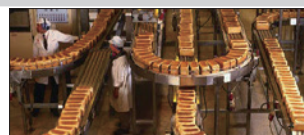

65°C LED High Bay Light (HB-U2)



Working Temp 65°C
UP TO 160lm/w



PHOTOMETRIC

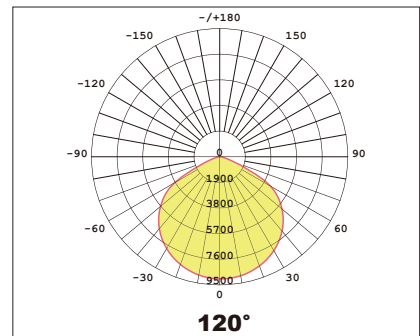
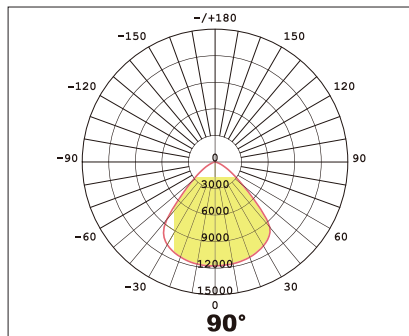
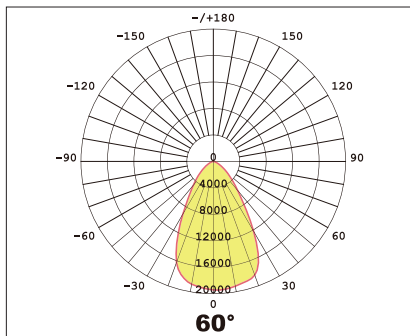

PARAMETER

MODEL NO.	POWER	VOLTAGE	BEAM ANGLE	LUMENS	CRI	Dimmable
HB-100U2	100W	100-277Vac	60° 90° 120°	160LM/W	80+	1-10V/DALI
HB-150U2	150W	100-277Vac	60° 90° 120°	160LM/W	80+	1-10V/DALI
HB-200U2	200W	100-277Vac	60° 90° 120°	160LM/W	80+	1-10V/DALI

LED High Bay Light (HB-U3)



FEATURES

- Die-Casting Aluminum
- IP66 Wet Location
- luminous Efficacy: 140-160lm/w
- Type 60° 90° 120°



AVAILABLE OPTIONS



Hanging Rings



Trestle Bracket



Reflector

PARAMETER

MODEL NO.	POWER	VOLTAGE	BEAM ANGLE	LUMENS	CRI	Dimmable
HB-60U3	60W	100-277Vac	60° 90° 120°	150LM/W	80+	1-10V/DALI
HB-80U3	80W	100-277Vac	60° 90° 120°	150LM/W	80+	1-10V/DALI
HB-100U3	100W	100-277Vac	60° 90° 120°	150LM/W	80+	1-10V/DALI
HB-150U3	150W	100-277Vac	60° 90° 120°	150LM/W	80+	1-10V/DALI
HB-200U3	200W	100-277Vac	60° 90° 120°	150LM/W	80+	1-10V/DALI
HB-240U3	240W	100-277Vac	60° 90° 120°	150LM/W	80+	1-10V/DALI

High Power LED High Bay (aBay)



FEATURES

- Die-Casting Aluminum
- IP66 Wet Location
- 130-160lm/w
- 1-10V dimmable



AVAILABLE OPTIONS



Hanging or mounted



High Post Bracket

DIMENSION

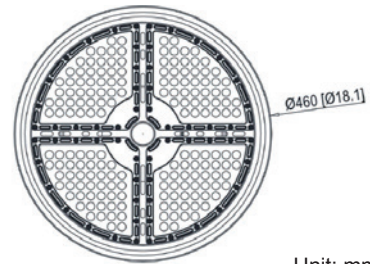
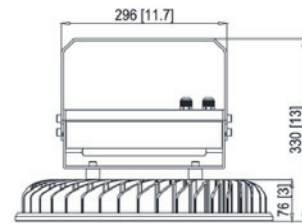

Unit: mm ["]

PARAMETER

MODEL NO.	POWER	VOLTAGE	BEAM ANGLE	LUMENS	Dimmable
HB-400A	400W	100-277Vac	30° 60° 90° 110°	130-160lm/w	1-10V
HB-500A	500W	100-277Vac	30° 60° 90° 110°	130-160lm/w	1-10V
HB-600A	600W	100-277Vac	30° 60° 90° 110°	130-160lm/w	1-10V

LED Linear High bay (eBay)



FEATURES

- IK10
- IP65 Waterproof
- Aluminum+PC Lens
- PC Lens
- 60°, 90°, 30x70°, 60x90°, 80x140°



AVAILABLE OPTIONS



Rectangular beam, meet the channel lighting requirement

Surface Mounted

Hanging

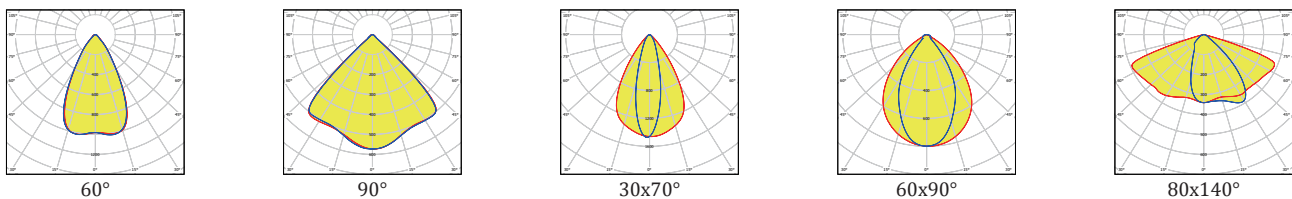

PARAMETER

MODEL NO.	POWER	VOLTAGE	BEAM ANGLE	LUMENS	CRI	Dimmable
HB-50E	50W	100-277Vac		130lm/w	80+	1-10V
HB-100E	100W	100-277Vac		130lm/w	80+	1-10V
HB-150E	150W	100-277Vac	60°	130lm/w	80+	1-10V
HB-200E	200W	100-277Vac	90°	130lm/w	80+	1-10V
HB-300E	300W	100-277Vac	30° x70°	130lm/w	80+	1-10V
HB-400E	400W	100-277Vac	60° x90°	130lm/w	80+	1-10V
			80° x140°	130lm/w	80+	1-10V

LED Linear High Bay (LHB-D)

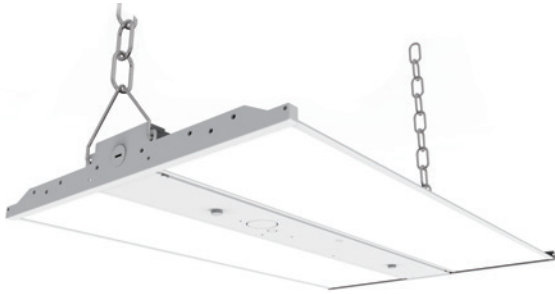

FEATURES

- Feature
- Power selectable
- CCT Selectable
- Multi-Voltage: 100-277/347Vac, 1-10V in standard
- High Lumens 150lm/w with well-distributed and soft light.
- Lifespan L80>100,000 Hours
- Sensor and Emergency optional



AVAILABLE OPTIONS

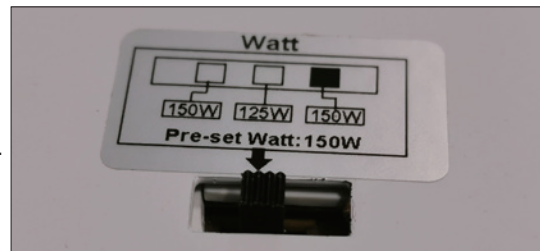

PARAMETER

MODEL NO.	Dimension	POWER	VOLTAGE	BEAM ANGLE	CRI	LUMENS	Dimmable
LHB-60/80/100D	2FT	60W/80W/100W(Settable)	100-277VAC	120°	80+	150lm/w	1-10V
LHB-125/150/165D	2FT	125W/150W/165W(Settable)	100-277VAC	120°	80+	150lm/w	1-10V
LHB-180/200/220D	4FT	180W/200W/220W(Settable)	100-277VAC	120°	80+	150lm/w	1-10V
LHB-250/300D	4FT	250W/300W(Settable)	100-277VAC	120°	80+	150lm/w	1-10V

LED Flood Light (FL-F3)



20W -600W

FEATURES

- Die-Casting Aluminum
- PC Lens +Tempered Glass
- IP66 Wet Location
- 130lm/w CRI>80
- 30/60/90/120/TYPE3 Beam angle
- Color Temp Selectable



CCT SELECTABLE



Beam Angle

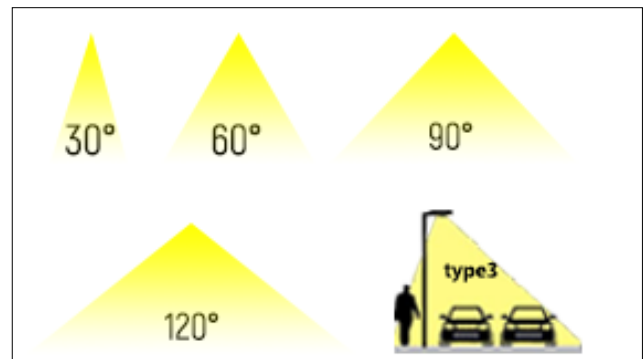

PARAMETER

MODEL NO.	POWER	VOLTAGE	BEAM ANGLE	LUMENS	CRI	Dimmable
FL-30F3	30W	200-240Vac	30 60 90 120 TYPE3	130LM/W	80+	1-10V
FL-50F3	50W	200-240Vac	30 60 90 120 TYPE3	130LM/W	80+	1-10V
FL-80F3	80W	200-240Vac	30 60 90 120 TYPE3	130LM/W	80+	1-10V
FL-150F3	150W	200-240Vac	30 60 90 120 TYPE3	130LM/W	80+	1-10V
FL-180F3	180W	200-240Vac	30 60 90 120 TYPE3	130LM/W	80+	1-10V
FL-200F3	200W	200-240Vac	30 60 90 120 TYPE3	130LM/W	80+	1-10V
FL-250F3	250W	200-240Vac	30 60 90 120 TYPE3	130LM/W	80+	1-10V
FL-300F3	300W	200-240Vac	30 60 90 120 TYPE3	130LM/W	80+	1-10V
FL-400F3	400W	200-240Vac	30 60 90 120 TYPE3	130LM/W	80+	1-10V
FL-500F3	500W	200-240Vac	30 60 90 120 TYPE3	130-160lm/w	80+	1-10V
FL-600F3	600W	200-240Vac	30 60 90 120 TYPE3	130-160lm/w	80+	1-10V

LED Flood Area Light(FLB)

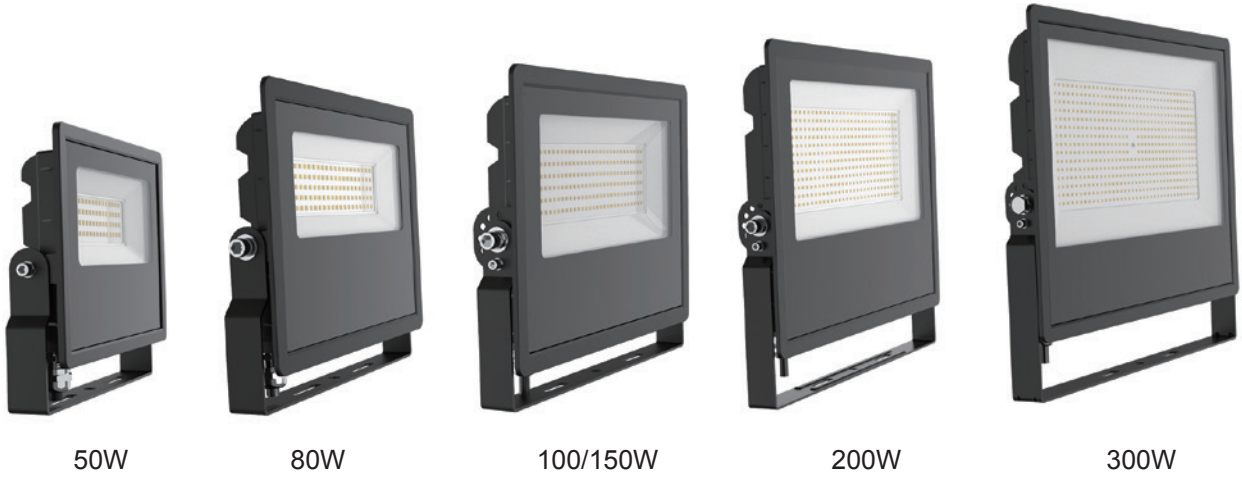

FEATURES

- Die-Casting Aluminum
- Tempered Glass Cover
- IP66 Wet Location
- 120lm/w CRI > 80Ra
- Internal High Quality Driver
- Multi-Voltage:100-277V/347V



LM80 LED Chips
L70>100,000 Hours

Die-Casting Aluminum Body
With good heat dissipation



Tempered Glass Cover
Daylight-Resistant



Internal High Quality Driver

PARAMETER

MODEL NO.	POWER	VOLTAGE	BEAM ANGLE	LUMENS	CRI
FLB-50W	50W	100-277V/347V	120°	120lm/w	80+
FLB-80W	80W	100-277V/347V	120°	120lm/w	80+
FLB-100W	100W	100-277V/347V	120°	120lm/w	80+
FLB-150W	150W	100-277V/347V	120°	120lm/w	80+
FLB-200W	200W	100-277V/347V	120°	120lm/w	80+
FLB-300W	300W	100-277V/347V	120°	120lm/w	80+

LED Flood Light(FL-C)

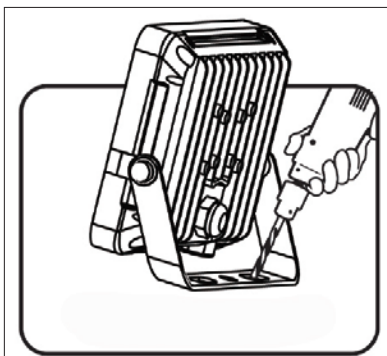

Angled Mounting Bracket for Electrician Quick Fix



Have an integrated visor that observable glare



Suitable for ground mounting
Specialized Drainage Notch
For Drain away water.
Don't worry the water will go
into the lamp body!

PARAMETER

MODEL NO.	POWER	VOLTAGE	BEAM ANGLE	LUMENS	CRI
FL-30C2-E	26W	100-277V	100°	135LM/W	80+
FL-50C2-E	50W	100-277V	100°	130LM/W	80+
FL-80C3-E	80W	100-277V	100°	140LM/W	80+
FL-100C3-E	100W	100-277V	100°	140LM/W	80+
PL01-150W-F	150W	100-277V	160x110°	140LM/W	80+
PL01-200W-F	200W	100-277V	160x110°	140LM/W	80+

Easy Clean LED Flood Light (FL-H)



FEATURES

- Die-Casting Aluminum
- PC Lens + Tempered Glass
- IP66 Wet Location
- 130lm/w CRI >80
- 30/60/90/120/TYPE3 Beam angle



Beam Angle

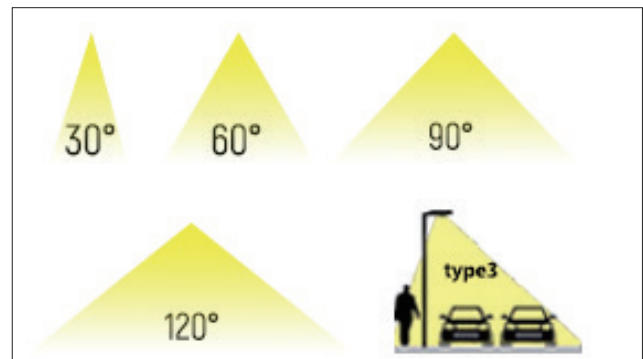

PARAMETER

MODEL NO.	POWER	VOLTAGE	BEAM ANGLE	LuminousEfficacy	LUMENS	CRI
FL-100H	100W	100-277VAC	30 60 90 120 TYPE3	130LM/W	13000	80+
FL-150H	150W	100-277VAC	30 60 90 120 TYPE3	130LM/W	19500	80+
FL-200H	200W	100-277VAC	30 60 90 120 TYPE3	130LM/W	26000	80+
FL-250H	250W	100-277VAC	30 60 90 120 TYPE3	130LM/W	32500	80+
FL-300H	300W	100-277VAC	30 60 90 120 TYPE3	130LM/W	39000	80+

Corrosion Resistance LED Area Light (FLA)

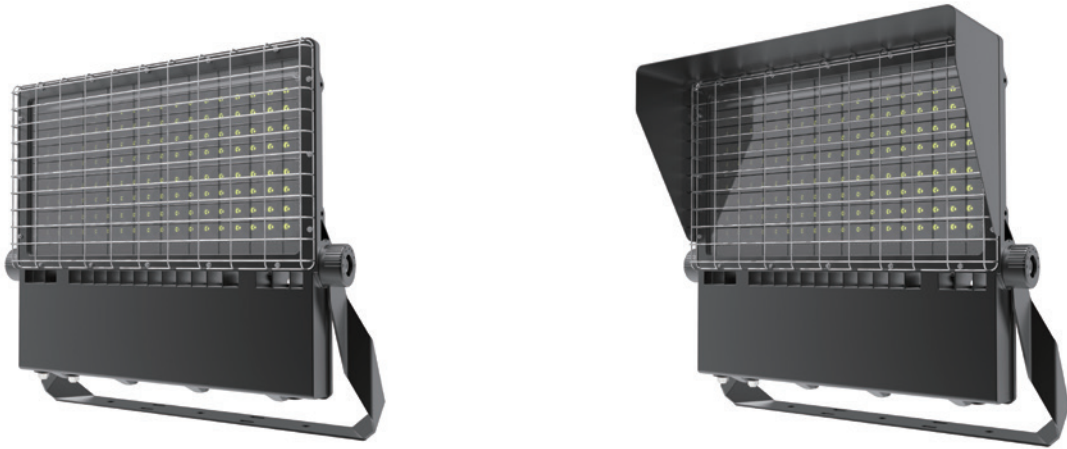

Corrosion Resistance more than 10 years

FEATURES

- LM-6 Aluminum body
- 316 Stainless Steel Bracket
- AkzoNobel 10 Years Powder-coating
- Salt Spray Test 1500 Hours
- IP66 and IK10 Rating



Beam Angle

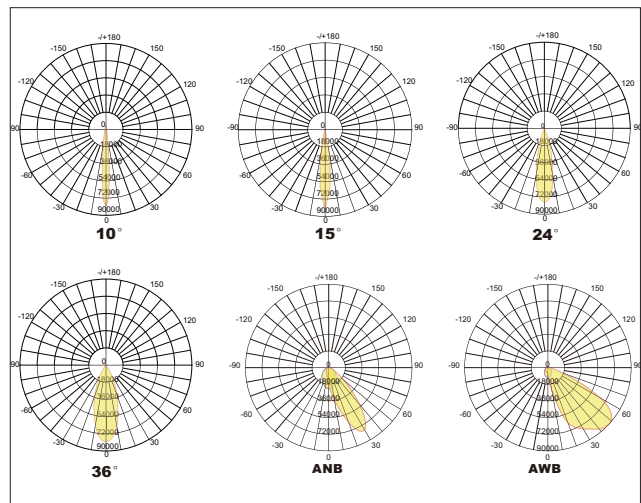

PARAMETER

MODEL NO.	POWER	VOLTAGE	LuminousEfficacy	LUMENS	CRI	UGR	Beam Angle	Dimmable
FLA-350W	350W	185-305Vac	140lm/w	38500	70+	19	10° 15°	0-10V/DALI
FLA-500W	500W	185-305Vac	140lm/w	55000	70+	19	24° 36°	0-10V/DALI
FLA-600W	600W	185-305Vac	140lm/w	66000	70+	19	ANB ANWB	0-10V/DALI

LED Stadium Spot Light(HPA)



FEATURES

- Die-Casting Aluminum
- IP66 Wet Location
- UP to 160lm/w
- CRI>80
- Lifespan>100,000hours



PARAMETER

MODEL NO.	POWER	VOLTAGE	BEAM ANGLE	LUMENS	CRI
HB-320A	320W	100-277V	25° 45° 60° 90° 110°	160LM/W	80+
HB-400A	400W	100-277V	25° 45° 60° 90° 110°	160LM/W	80+
HB-500A	500W	100-277V	25° 45° 60° 90° 110°	160LM/W	80+
HB-600A	600W	100-277V	25° 45° 60° 90° 110°	160LM/W	80+

LED Stadium Spot Light(HPB)



FEATURES

- Die-Casting Aluminum
- IP66 Wet Location UP to 160lm/w
- CRI>80
- Lifespan>100,000hours



Super Light



Single Row(120-480W)

Double Row(480-1500W)

Transformers(720-1500W)

PARAMETER

MODEL NO.	POWER	VOLTAGE	BEAM ANGLE	LUMENS
HPB-120W	120W	100-305V	20° 40° 60° 90°140°x110°	160LM/W
HPB-240W	240W	100-305V	20° 40° 60° 90°140°x110°	160LM/W
HPB-360W	360W	100-305V	20° 40° 60° 90°140°x110°	160LM/W
HPB-480W	480W	100-305V	20° 40° 60° 90°140°x110°	160LM/W
HPB-720W	720W	100-305V	20° 40° 60° 90°140°x110°	160LM/W
HPB-960W	960W	100-305V	20° 40° 60° 90°140°x110°	160LM/W
HPB-1200W	1200W	100-305V	20° 40° 60° 90°140°x110°	160LM/W
HPB-1500W	1500W	100-305V	20° 40° 60° 90°140°x110°	160LM/W

LED Stadium Spot Light(HPM)



316 Stainless Steel Bracket

FEATURES

- IP66 Wet Location
- UP to 160lm/w
- P50,20° 60° 90°
- Lifespan>100,000hours



POWER: 240-1800W



PARAMETER

MODEL NO.	POWER	VOLTAGE	BEAM ANGLE	LUMENS
HPM-240W	240W	100-305V	P50° 10° 20° 60° 90°	160lm
HPM-300W	300W	100-305V	P50° 10° 20° 60° 90°	160lm
HPM-480W	480W	100-305V	P50° 10° 20° 60° 90°	160lm
HPM-600W	600W	100-305V	P50° 10° 20° 60° 90°	160lm
HPM-720W	720W	100-305V	P50° 10° 20° 60° 90°	160lm
HPM-900W	900W	100-305V	P50° 10° 20° 60° 90°	160lm
HPM-960W	960W	100-305V	P50° 10° 20° 60° 90°	160lm
HPM-1200W	1200W	100-305V	P50° 10° 20° 60° 90°	160lm
HPM-1500W	1500W	100-305V	P50° 10° 20° 60° 90°	160lm
HPM-1800W	1800W	100-305V	P50° 10° 20° 60° 90°	160lm

LED Street Light



SLA Series



SLB Series



SLC Series



- Photo cell**
Automatic switch for fixture according to the change of light intensity
- NB-IoT**
Intelligent interconnection control
- PHILIPS LED Driver NON-DIMMABLE**
Philips Xitanium or MW XLG series
- DIMMABLE**
Philips SR series, DALI2 agreement, class I or class II option, good performance and lifespan
- Breather**
Breather ensure air balance inside and outside of the fixture, which can improve fixture's lifetime
- High-efficiency LED light source**
Philips Lumileds 3030 LED Greater than 176lm/w high efficacy illumination grade led light source
- Power turn off protector**
When the lamp maintenance, Open lamp flash, Internal power lamp, Protect the safety of personnel.
- WAGO quick connector**
Disassemble easily which reduces maintenance costs.
- Surge protection device(10KV)**
To provide more reliable guarantee for LED drive power, extend the life of the product.
- Level bubble**
Easy for the installer to adjust the position of the lamp.

NEMA 3-5-7 position for PHOTOCELL or SMART CONTROL Basic framework of Intelligent Lighting system



LED Street Light(SLA)



FEATURES

- Pure Aluminum IK08
- Lens+Tempered Glass
- IP66 waterproof Power
- Power cut-off protector
- Surge protection 10KV/20KV
- UP to 140-160lm/w CRI>80
- Photocell, Zigbee, NB-Iot for Smart cities

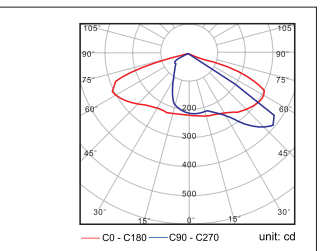
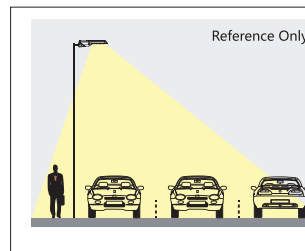
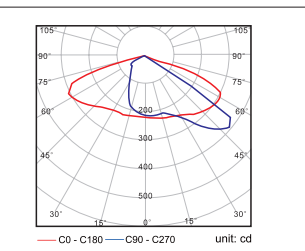
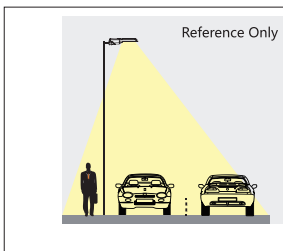
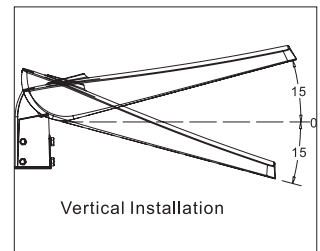
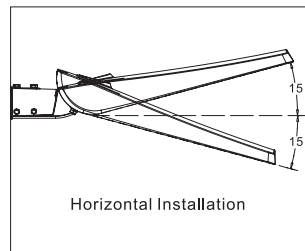
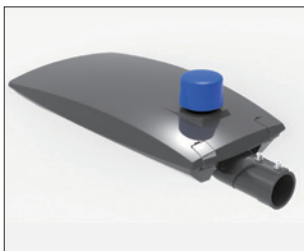

PARAMETER

MODEL NO.	POWER	VOLTAGE	BEAM ANGLE	LUMENS	CRI
SLA-40W	40W	100-277V	ME1-ME5	140-160LM/W	70+ /80+
SLA-60W	60W	100-277V	ME1-ME5	140-160LM/W	70+ /80+
SLA-80W	80W	100-277V	ME1-ME5	140-160LM/W	70+ /80+
SLA-100W	100W	100-277V	ME1-ME5	140-160LM/W	70+ /80+
SLA-120W	120W	100-277V	ME1-ME5	140-160LM/W	70+ /80+
SLA-150W	150W	100-277V	ME1-ME5	140-160LM/W	70+ /80+
SLA-180W	180W	100-277V	ME1-ME5	140-160LM/W	70+ /80+
SLA-200W	200W	100-277V	ME1-ME5	140-160LM/W	70+ /80+

LED Street Light(SLB)



RAL7024



FEATURES

- Pure Aluminum IK08
- Lens+Tempered Glass
- IP66 waterproof
- Power cut-off protector
- Surge protection 10KV/20KV
- UP to 140-160lm/w CRI>80
- Photocell, Zigbee, NB-Iot for Smart cities

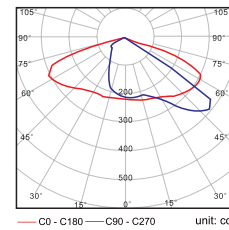
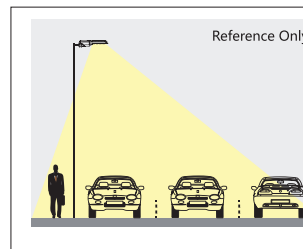
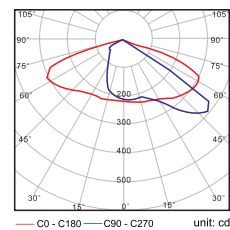
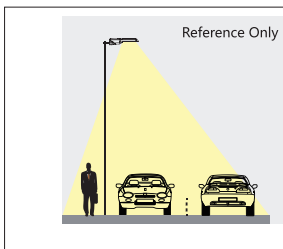
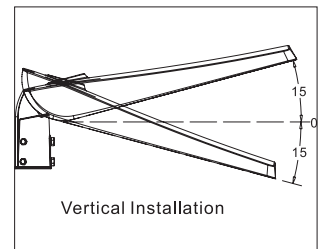
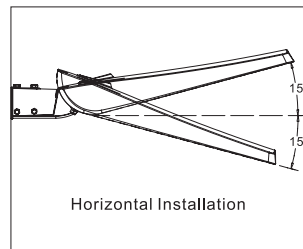

PARAMETER

MODEL NO.	POWER	VOLTAGE	BEAM ANGLE	LUMENS	CRI
SLB-48W	48W	100-277V	ME1-ME5	140-160LM/W	70+ /80+
SLB-55W	55W	100-277V	ME1-ME5	140-160LM/W	70+ /80+
SLB-65W	65W	100-277V	ME1-ME5	140-160LM/W	70+ /80+
SLB-75W	75W	100-277V	ME1-ME5	140-160LM/W	70+ /80+
SLB-90W	90W	100-277V	ME1-ME5	140-160LM/W	70+ /80+
SLB-105W	105W	100-277V	ME1-ME5	140-160LM/W	70+ /80+
SLB-120W	120W	100-277V	ME1-ME5	140-160LM/W	70+ /80+
SLB-150W	150W	100-277V	ME1-ME5	140-160LM/W	70+ /80+
SLB-180W	180W	100-277V	ME1-ME5	140-160LM/W	70+ /80+

LED Street Light(SLC)

RAL7042

RAL7024



FEATURES

- Pure Aluminum IK08
- Lens+Tempered Glass
- IP66 waterproof
- Power cut-off protector
- Surge protection 10KV/20KV
- UP to 140-160lm/w CRI>80
- Photocell, Zigbee, NB-Iot for Smart cities

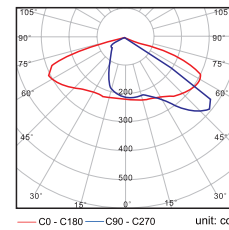
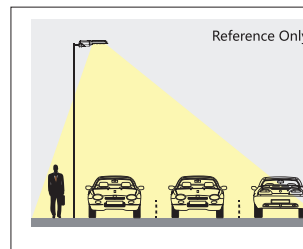
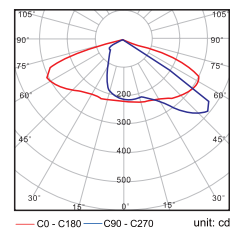
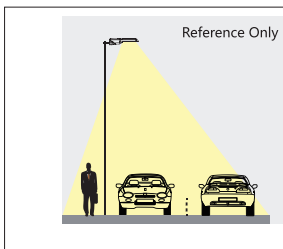
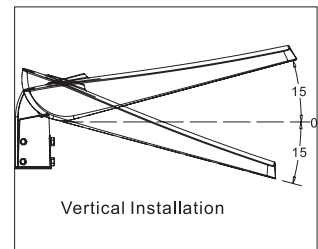
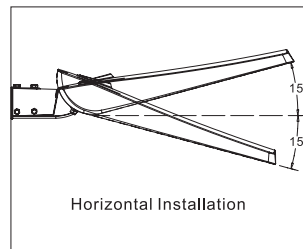
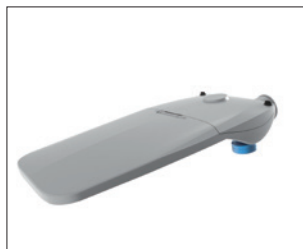

PARAMETER

MODEL NO.	POWER	VOLTAGE	BEAM ANGLE	LUMENS	CRI
SLC-40W	40W	100-277V	ME1-ME5	140-160LM/W	70+ /80+
SLC-60W	60W	100-277V	ME1-ME5	140-160LM/W	70+ /80+
SLC-80W	80W	100-277V	ME1-ME5	140-160LM/W	70+ /80+
SLC-100W	100W	100-277V	ME1-ME5	140-160LM/W	70+ /80+
SLB-120W	120W	100-277V	ME1-ME5	140-160LM/W	70+ /80+
SLC-150W	150W	100-277V	ME1-ME5	140-160LM/W	70+ /80+
SLC-180W	180W	100-277V	ME1-ME5	140-160LM/W	70+ /80+
SLC-200W	200W	100-277V	ME1-ME5	140-160LM/W	70+ /80+

LED Street Light (PKC)



RAL7024



FEATURES

- Die-Casting Aluminum with PC lens
- IP66
- IK09
- Surge Protection: 10KA
- UP TO 130-150lm/w
- Easy to Install and change adaptor



BEAM ANGLE

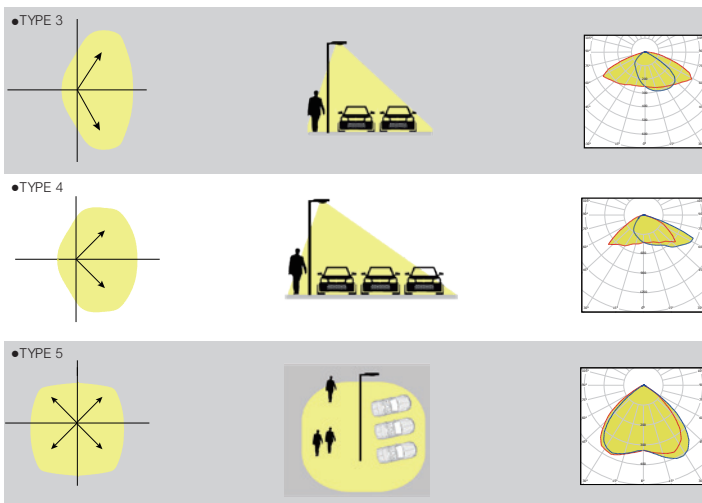

AVAILABLE OPTIONS



PARAMETER

MODEL NO.	POWER	VOLTAGE	BEAM ANGLE	LUMENS
PKC-100W	80W/100W/120W Switchable	100-277V/347V 277-480V	TYPE 3, 4, 5	140lm/w
PKC-150W	100W/120W/150W Switchable	100-277V/347V 277-480V	TYPE 3, 4, 5	140lm/w
PKC-200W	180W/200W/240W Switchable	100-277V/347V 277-480V	TYPE 3, 4, 5	140lm/w
PKC-300W	250W/300W Switchable	100-277V/347V 277-480V	TYPE 3, 4, 5	140lm/w



LED Tri-proof Light (VPB)



FEATURES

- Private Model
- AC120-277V/347V optional
- IP65 Wet Location, IK08
- High efficacy, 130lm/w
- Bi-Level Sensor optional



Integrated Design
Diffuse integrated with lighting tray, MAX to 130lm/w



Adjustable Brackets
Easy for installation



Dimmable+ Sensor
Selectable



Built-in Smart Sensor Rolsystem

PARAMETER

MODEL NO.	SIZE	POWER	VOLTAGE	LUMENS	BEAM ANGLE	CRI	Dimmable
VP4-36B-XX	1175mm	40W	200-240Vac	130lm/w	120°	80+	1-10V

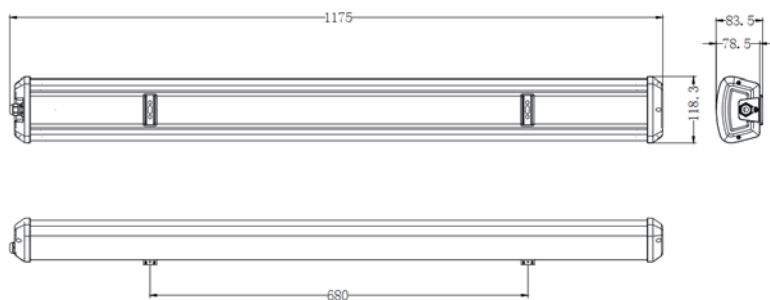
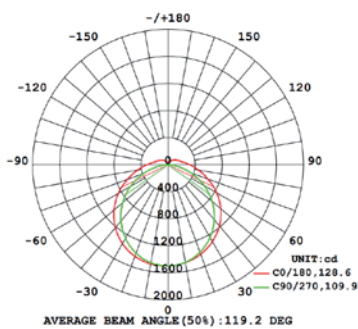

LED Tri-proof Light (TPC)

TUV ENEC CB Approval



Dimming



Emergency



Sensor



Power Selectable

FEATURES

- IP66 Wet Location
- IK10
- Luminous Efficacy 150lm/w
- CRI>80, SDCM<5
- 0-10V/ DALI/ Sensor/ Emergency
- Easy to mount(2-steps)

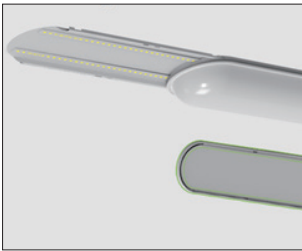

Advanced design

- Diffuser integrated with lighting tray
- Save installation steps and time
- Provide protection on LEDs



IP66

-40°C ~ 50°C
working temperature



Mounting Tolerance

+/-40MM



Connection of power

From Several sides

PARAMETER

MODEL NO.	SIZE	POWER	VOLTAGE	LUMENS	BEAM ANGLE	CRI
TPC-2A	600mm	20W	200-240Vac	130-150lm/w	120°	80+
TPC-4A	1200mm	30W	200-240Vac	130-150lm/w	120°	80+
TPC-4A	1200mm	40W	200-240Vac	130-150lm/w	120°	80+
TPC-4A (PS)	1200mm	30W/40W(Settable)	200-240Vac	130-150lm/w	120°	80+
TPC-5A	1500mm	60W	200-240Vac	130-150lm/w	120°	80+
TPC-2B	600mm	30W	200-240Vac	130-150lm/w	120°	80+
TPC-4B	1200mm	50W	200-240Vac	130-150lm/w	120°	80+
TPC-4B(PS)	1200mm	30W/40W/50W(Settable)	200-240Vac	130-150lm/w	120°	80+
TPC-5B	1500mm	70W	200-240Vac	130-150lm/w	120°	80+



LED Tri-proof Light (TPB)



Dimming



Emergency



Sensor

FEATURES

- IP66 waterproof
- 120lm/w CRI>80
- Easy Wiring
- 0-10V, DALI, Sensor, Emergency



EASY TO WIRING AND LINKABLE

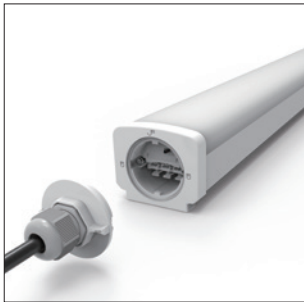

ToolFree for opening end cap

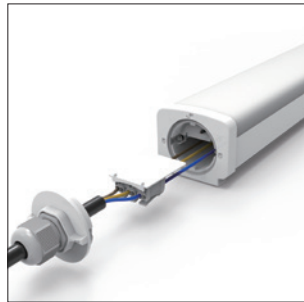

Easy to wiring

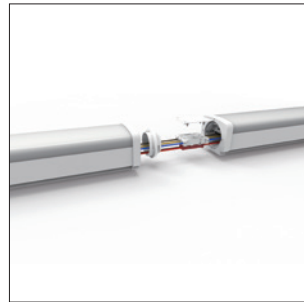

Easy Linkable

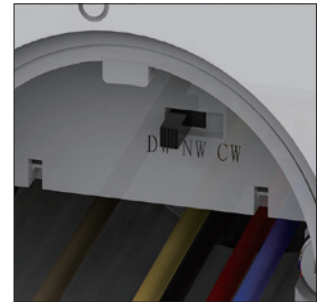

Power and CCT Selectable

PARAMETER

MODEL NO.	SIZE	POWER	VOLTAGE	Luminous Efficacy	BEAM ANGLE	CRI
TPB-20W-XXX-XX	630*74*62mm	20W	180-240Vac	120lm/w	120°	80+
TPB-40W-XXX-XX	1230*74*62mm	40W	180-240Vac	120lm/w	120°	80+
TPB-60W-XXX-XX	1530*74*62mm	60W	180-240Vac	120lm/w	120°	80+

Smart Function	1-10V Dim	DALI	Sensor	Emergency	Power and 3CCT Selectable
-----------------------	-----------	------	--------	-----------	---------------------------



Eco LED Tri-proof Light(TPD)

Cost-Effective



Emergency



Sensor



CCT Selectable

FEATURES

- IP66 waterproof
- IK10
- 120lm/w, CRI>80
- CCT settable, Sensor, Emergency



AVAILABLE OPTIONS

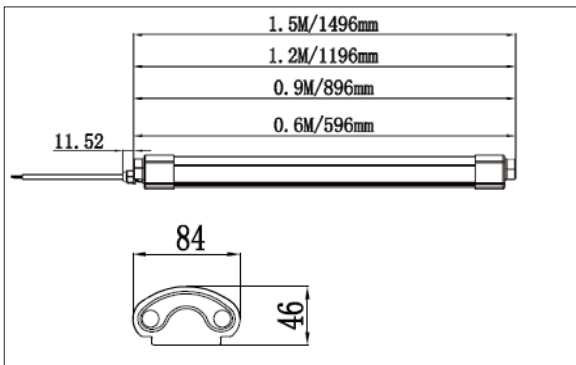

PHOTOMETRIC

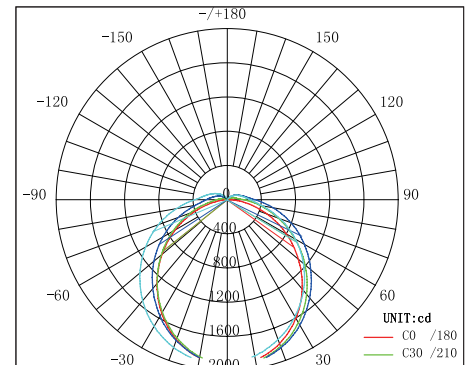

PARAMETER

MODEL NO.	SIZE	POWER	VOLTAGE	BEAM ANGLE	LUMENS	CRI
TPL600-20D	600mm	20W	200-240VAC	120°	120LM/W	80+
TPL1200-40D	1200mm	40W	200-240VAC	120°	120LM/W	80+
TPL1500-60D	1500mm	60W	200-240VAC	120°	120LM/W	80+
TPL1800-72D	1800mm	72W	200-240VAC	120°	120LM/W	80+



LED Tri-proof Light(VPE)



FEATURES

- Aluminum lamp body
- IP66 Wet Location
- 140lm/w and 150lm/w optional
- Multi-Voltage: 120-347Vac optional
- Easy wiring and linkable
- 0-10V dimming optional
- Bi-level Sensor, Emergency optional



ADVANTAGE



Quickly open endcap and tool Free, Easy wiring



Easy Linkable and tool-Free

PARAMETER

MODEL NO.	SIZE	POWER	VOLTAGE	BEAM ANGLE	LUMENS	CRI
VPE-440	4FT	40W	100-277V/120-347V	120°	140LM/W	80+
VPE-460	4FT	60W	100-277V/120-347V	120°	140LM/W	80+
VPE-580	5FT	80W	100-277V/120-347V	120°	140LM/W	80+
VPE-890	8FT	90W	100-277V/120-347V	120°	140LM/W	80+
VPE-8120	8FT	120W	100-277V/120-347V	120°	140LM/W	80+

UGR19 LED Tri-proof Light(TPE)

Anti-glare (UGR 19) Soft Lighting



FEATURES

- IP66 waterproof
- 120lm/w, CRI>80
- Anti-Glare Soft Lighting
- Easy Connection



EASY CONNECTION

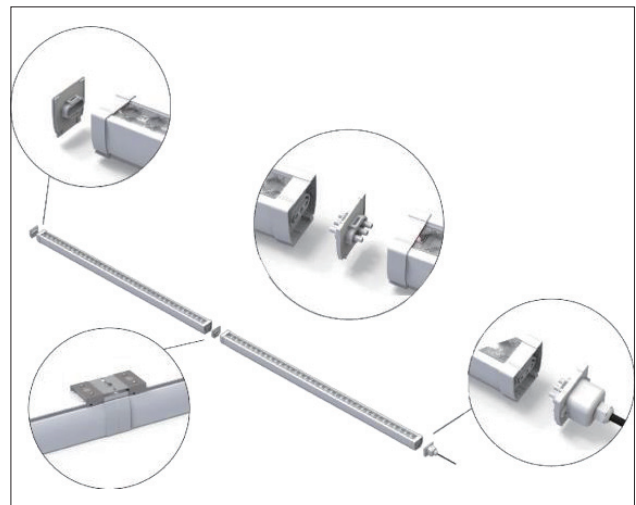
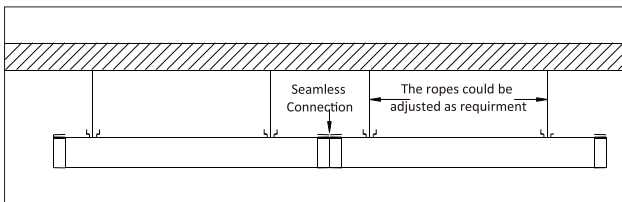

PARAMETER

MODEL NO.	SIZE	POWER	VOLTAGE	BEAM ANGLE	LUMENS	CRI
TPE-40W	1200mm	40W	200-240VAC	120	120LM/W	80+
TPE-50W	1500mm	50W	200-240VAC	120	120LM/W	80+

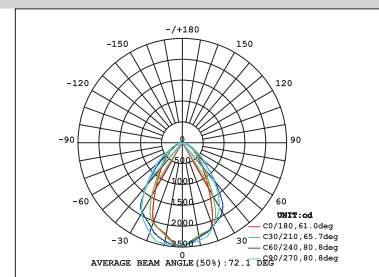
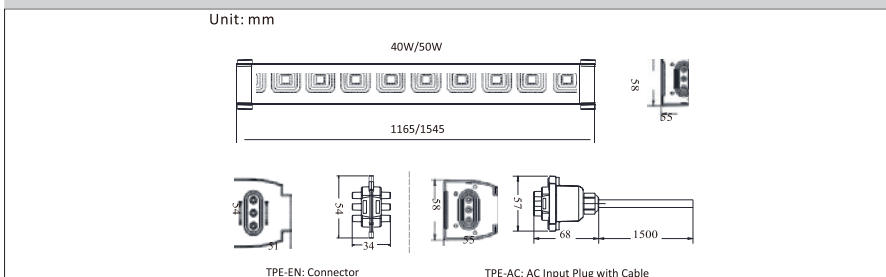

Back-Lit Panel Light(BPL)



FEATURES

- Ultrathin 24mm
- 110lm/w or 140lm/w
- CRI>80 or CRI>90
- UGR<19 optional
- SDCM<3
- Flicker Free
- Dimmable: Triac/0-10V/DALI
- Power Dip Switch

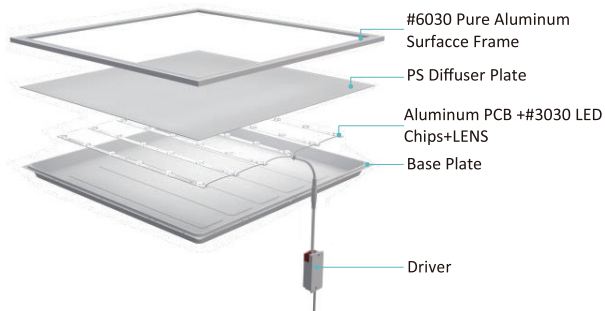
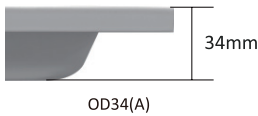

AVAILABLE OPTIONAL

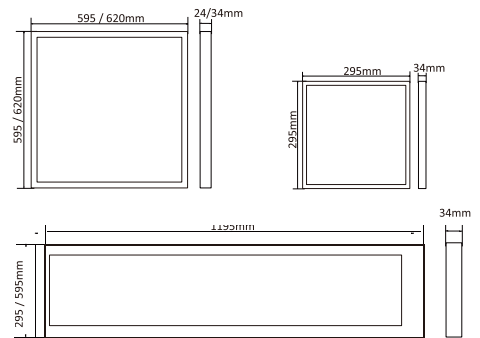

PARAMETER

MODEL NO.	DIMENSION	POWER	VOLTAGE	BEAM ANGLE	LUMENS	CRI
BPL3030A-18W	295x295x34mm	18W	200-240Vac	120°	110/140 LM/W	80+/90+
BPL6060A-36W	595x595x34mm	36W/27W	200-240Vac	120°	110/140 LM/W	80+/90+
BPL6262A-36W	620x620x34mm	36W/27W	200-240Vac	120°	110/140 LM/W	80+/90+
BPL30120A-36W	295x1195x34mm	36W/27W	200-240Vac	120°	110/140 LM/W	80+/90+
BPL60120A-54W	595x1195x34mm	54W	200-240Vac	120°	110/140 LM/W	80+/90+

Smart Function	Triac Dim	0-10V Dim	DALI Dim	2.4G Remote	WIFI APP
----------------	-----------	-----------	----------	-------------	----------

Edge-Lit Panel Light(PL-H)

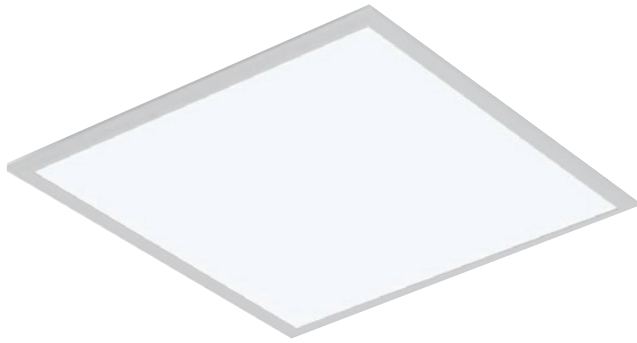

150LM/W UGR<16

FEATURES

- Super High lumens 150lm/w or 140lm/w
- CRI>80 or CRI>90
- UGR<19 or UGR<16 optional
- SDCM<3
- Flicker Free
- Dimmable: Triac/0-10V/DALI

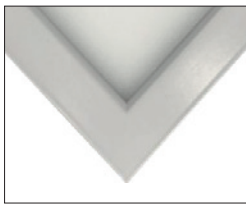

Ch10 Frame (Stripless)



T=12

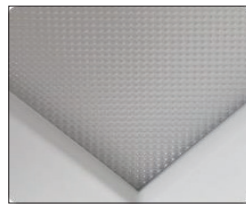

UGR19

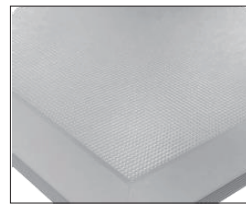

UGR16

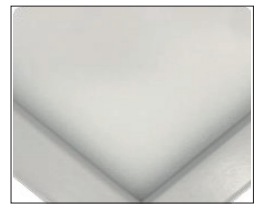

Routine

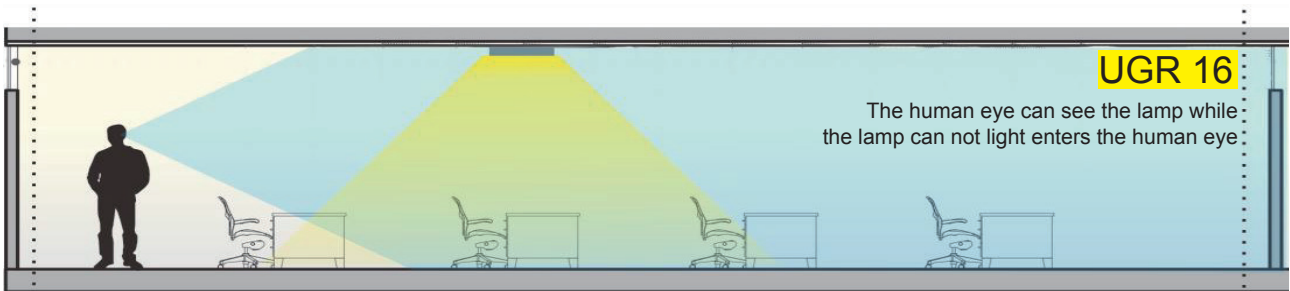

PARAMETER

MODEL NO.	DIMENSION	POWER	VOLTAGE	BEAM ANGLE	LUMENS	CRI
PL6060-27W-H	595x595x12mm	27W	200-240Vac	120°	150/140W LM/W	80+/90+
PL6262-27W-H	620x620x12mm	27W	200-240Vac	120°	150/140W LM/W	80+/90+
PL30120-27W-H	295x1195x12mm	27W	200-240Vac	120°	150/140W LM/W	80+/90+
PL60120-54W-H	595x1195x12mm	54W	200-240Vac	120°	150/140W LM/w	80+/90+

Power and CCT Dimmable Panel Light

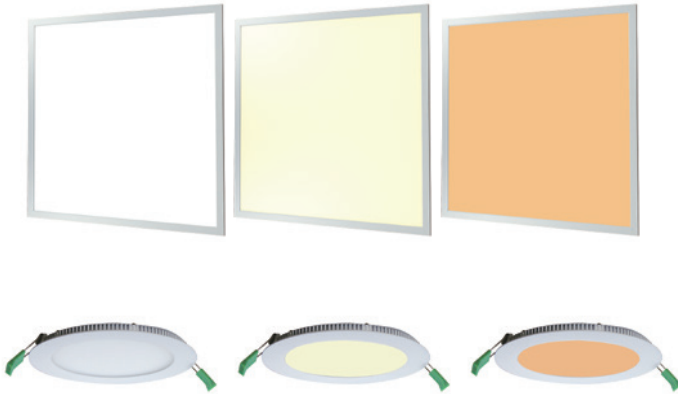

FEATURES

- Stepless adjusted CCT & Dimmable, Freely switch between warm white and cool white
- Traic Diming, RF-2.4G wireless control or DALI DT8 control
- Stylish appearance, practical function, easily operation. Dimming & Color temperature adjustable, synchronous control
- CRI>80, SDCM<5
- Flicker Free



CCT DIP Switchable



3CCT:
 WW: 3000K
 NW: 4000K
 CW: 6000K

2CCT:
 WW: 3000K
 NW: 4000K

CCT Dimmable



Square CCT Panel Light

MODEL NO.	DIMENSION	POWER	VOLTAGE	LUMENS	CRI
BPL6060A-XX-CCT	595x595x34mm	27W/30W/36W	200-240Vac	120-130lm/w	80+/90+
BPL6262A-XX-CCT	620x620x34mm	27W/30W/36W	200-240Vac	120-130lm/w	80+/90+
BPL30120A-XX-CCT	295x1195x34mm	27W/30W/36W	200-240Vac	120-130lm/w	80+/90+
BPL60120A-XX-CCT	595x1195x34mm	27W/30W/40W	200-240Vac	120-130lm/w	80+/90+

Round CCT Panel Light

MODEL NO.	DIMENSION	CUT-OUT	POWER	VOLTAGE	LUMENS	CRI
PL120R-8W	D120x15mm	D100mm	8W	200-240Vac	100LM/w	80+/90+
PL180R-10W	D180x15mm	D160mm	10W	200-240Vac	100LM/w	80+/90+
PL240R-18W	D240x15mm	D220mm	18W	200-240Vac	100LM/w	80+/90+
PL300R-24W	D300x15mm	D280mm	24W	200-240Vac	100LM/w	80+/90+

Suspending Big Round Panel Light(PLW-S)



FEATURES

- High Quality Aluminum frame
- Ultrathin only 12mm(0.47inch)
- 110lm/w, CRI>90,SDCM<3
- Flicker Free
- Triac dim, 0-10V dim, CCT changeable
- Installation: suspending, Mount



Suspending



Surface Mount

Multiple Size	Φ300mm (12")	Φ400mm (16")	Φ500mm (20")	Φ600mm (24")	Φ800mm (32")	Φ900mm (36")	Φ1000mm (40")
---------------	--------------	--------------	--------------	--------------	--------------	--------------	---------------

PARAMETER

MODEL NO.	DIMENSION	POWER	VOLTAGE	LUMENS	LUMENS	CRI
PLW300-18W	D300x12mm	18W	200-240Vac	1800LM	110LM/W	90+
PLW400-26W	D400x12mm	26W	200-240Vac	2800LM	110LM/W	90+
PLW500-30W	D500x12mm	30W	200-240Vac	3300LM	110LM/W	90+
PLW600-40W	D600x12mm	40W	200-240Vac	4400LM	110LM/W	90+
PLW800-50W	D800x12mm	50W	200-240Vac	5500LM	110LM/W	90+
PLW900-60W	D900x12mm	60W	200-240Vac	6600LM	110LM/W	90+
PLW1000-75W	D1000x12mm	75W	200-240Vac	8000LM	110LM/W	90+

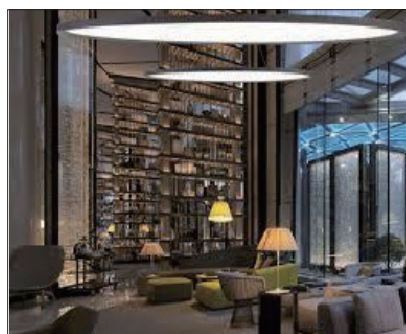

Recessed Big Round Panel Light(PLW-R)



FEATURES

- High Quality Aluminum frame
- Ultrathin only 12mm(0.47inch)
- 110lm/w, CRI>90,SDCM<3
- Flicker Free
- Triac dim, 0-10V dim, CCT changeable
- Installation: suspending, Mount



Recessed

PARAMETER

MODEL NO.	DIMENSION	Cut-out	POWER	BEAMANGLE	LUMENS	EFFICACY	CRI
PLW400-26W-xxK-x-R	Φ400x12mm	Φ380mm	26W	120°	2800lm	110lm/w	80+
PLW500-30W-xxK-x-R	Φ500x12mm	Φ480mm	30W	120°	3300lm	110lm/w	80+
PLW600-40W-xxK-x-R	Φ600x12mm	Φ580mm	40W	120°	4400lm	110lm/w	80+

Smart Function	Triac Dim	0-10V Dim	DALI Dim	2.4G Remote	WIFI APP
----------------	-----------	-----------	----------	-------------	----------



Small Panel Light(PL-R/S)

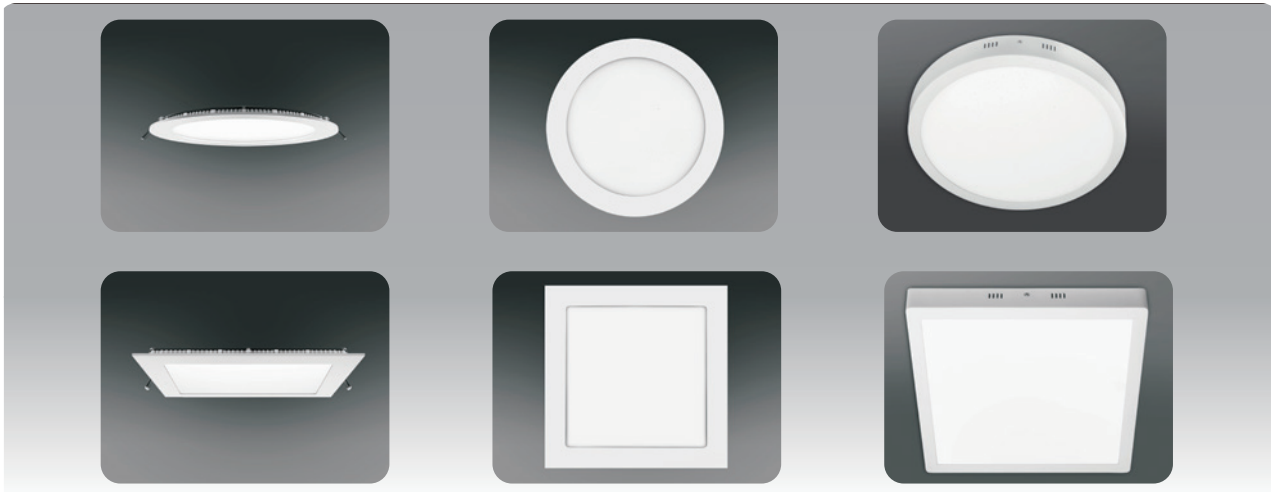

RECESSED

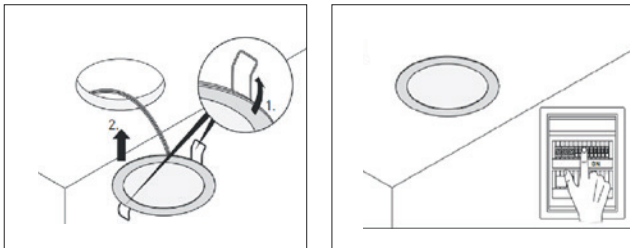

MOUNTED

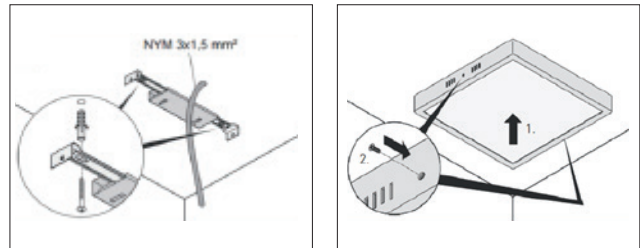

Round Series

MODEL NO.	DIMENSION	CUT-OUT	POWER	VOLTAGE	LUMENS	EFFICACY	CRI
PL120R-8W	D120x12mm	D105mm	8W	200-240Vac	600LM	80LM/w	80+
PL145R-10W	D145x12mm	D130mm	10W	200-240Vac	800LM	80LM/w	80+
PL180R-12W	D180x12mm	D160mm	12W	200-240Vac	1000LM	80LM/w	80+
PL200R-15W	D200x12mm	D180mm	15W	200-240Vac	1200LM	80LM/w	80+
PL240R-18W/20W	D240x12mm	D220mm	18/20W	200-240Vac	1500LM/1600LM	80LM/w	80+
PL300R-20W/24W	D300x12mm	D280mm	20/24W	200-240Vac	1600LM/1900LM	80LM/w	80+

Square Series

MODEL NO.	DIMENSION	CUT-OUT	POWER	VOLTAGE	LUMENS	EFFICACY	CRI
PL1111S-8W	110x110x12mm	90x90mm	8W	200-240Vac	600LM	80LM/w	80+
PL1616S-12W	160x160x12mm	140x140mm	12W	200-240Vac	1000LM	80LM/w	80+
PL1818S-12W	180x180x12mm	160x160mm	12W	200-240Vac	1000LM	80LM/w	80+
PL2020S-15W	120x120x12mm	180x180mm	15W	200-240Vac	1200LM	80LM/w	80+
PL2222S-18W	220x220x12mm	200x200mm	18W	200-240Vac	1500LM	80LM/w	80+
PL3030S-20W	300x300x12mm	280x280mm	20W	200-240Vac	1600LM	80LM/w	80+

Multi-Function Slim LED Panel Light(PLY)



FEATURES

- Surface Mounted + Recessed
- CCT Selectable
- Microwave Sensor
- Ultra-thin 20mm



ADVANTAGE OPTIONS

Microwave Sensor



CCT Selectable
3000K/4000K/6000K
Easy To Make Inventory Reserve

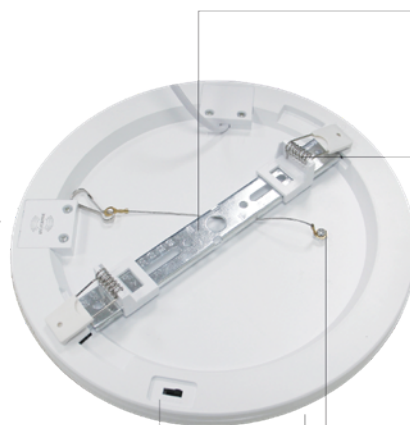

Surface Mounted
Concealed Bracket

Recessed
Adjustable Spring
For Different Cut-out

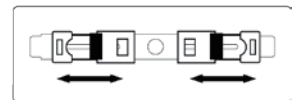

Safety Rope

Ultra-thin 20mm

PARAMETER

MODEL NO.	DIMENSION	POWER	Cut-out	BEAMANGLE	LUMENS	EFFICACY	CRI
PLY-S155-9W	155x155x20mm	9W	70-100mm	120°	630lm	70lm/w	80+
PLY-S175-12W	175x175x20mm	12W	70-120mm	120°	960lm	80lm/w	80+
PLY-S225-18W	225x225x20mm	18W	70-170mm	120°	1620lm	90lm/w	80+
PLY-S300-24W	300x300x20mm	24W	70-240mm	120°	2160lm	90lm/w	80+

Luna Series Smart Flush Mount Ceiling Light (CP)

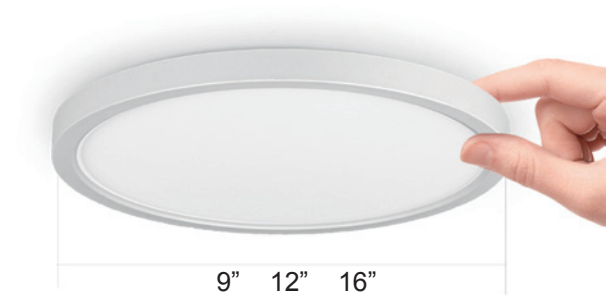
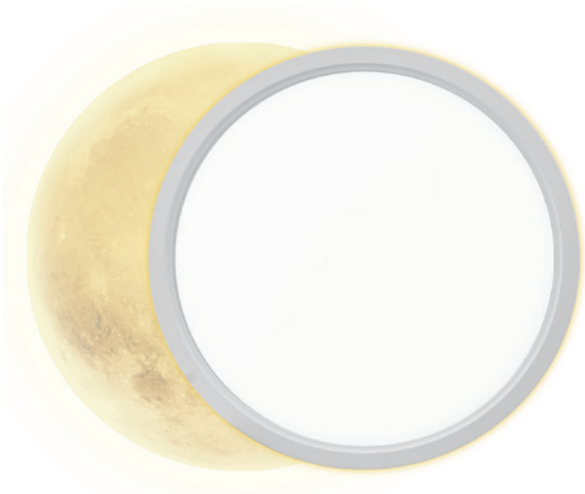

Simple LOOK Good LOOK
Height only 24mm(0.94inch)

SINGLE COLOR TYPE



3 COLOR SWITCHABLE TYPE



Luna Series Smart Flush Mount Ceiling Light (CP)

Color 3000K-6500K Dimmable Smart Type

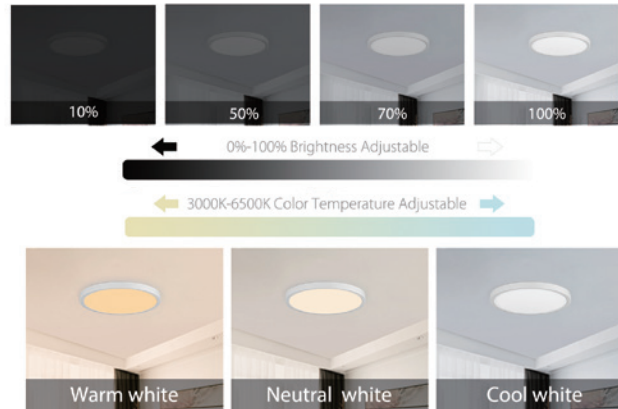

Front Light 3000K-6500K White +Back Light RGB Smart Type

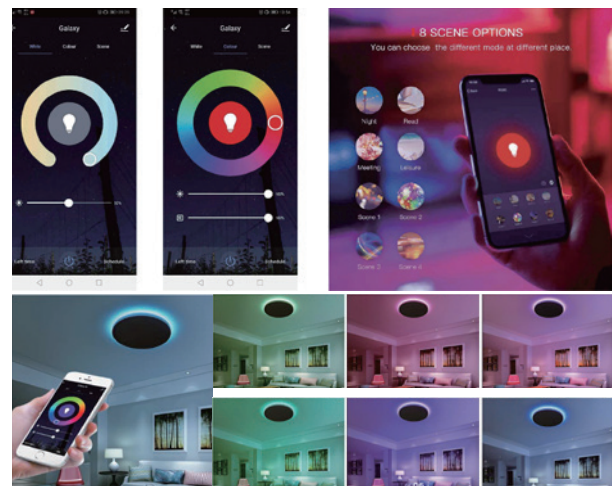

PARAMETER

MODEL NO.	Dimension	POWER	VOLTAGE	ANGLE	LEMENS	CRI	Function
CP225-18W	9"x0.94"	18W	120V	120°	1440lm	80+	Dimmable
CP300-24W	12"x0.94"	24W	120V	120°	2040lm	80+	Dimmable
CP400-36W	16"x0.94"	36W	120V	120°	3240lm	80+	Dimmable

EASY INSSLATION

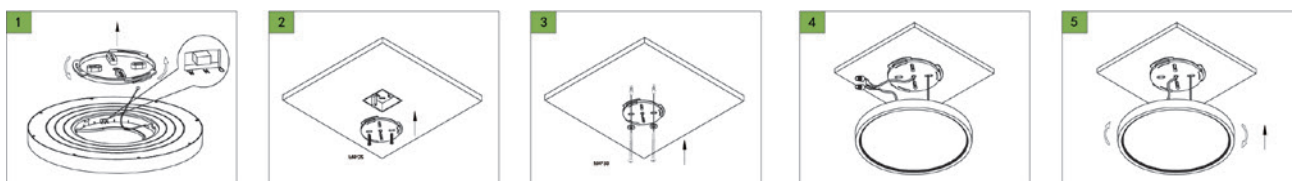

IP54 Ceiling Light (CLY)



FEATURES

- IP54 waterproof, suitable for bathroom, veranda etc...
- Full illumination
- internal driver, with mounting board for mounting easily
- 100lm/w, CRI>80, SDCM<5



ADVANTAGE OPTIONS



IP54 Waterproof



Easy to Mount

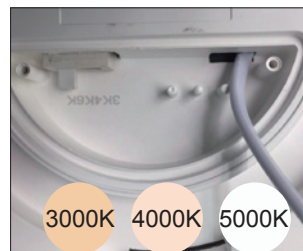

DIP Switch
CCT Selectable



2.4G CCT Changeable

PARAMETER

MODEL NO.	DIMENSION	POWER	VOLTAGE	BEAMANGLE	LUMENS	EFFICACY	CRI
CYL225-12W	D225x55mm	12W	200-240Vac	120°	1100lm	95lm/w	80+
CYL225-18W	D225x55mm	18W	200-240Vac	120°	1700lm	95lm/w	80+

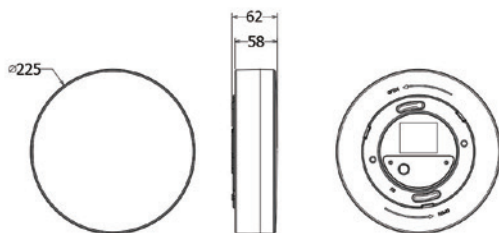

Downlight (A6)



Chip Partners

CITIZEN  

Driver Partners

TRIDONIC   



MODEL: DL-A6-3-7W

Power: 7W
Material: Die-casting ALU
Lumens :100lm/w
CRI : 83Ra
SMCM: <3
THD: <15%

Voltage: 200-240Vac
Flicker: Flicker Free
Beam Angle: 110°
CCT: 30K/40K/50K/60K
Optics: Reflector +PC cover
Finish: White

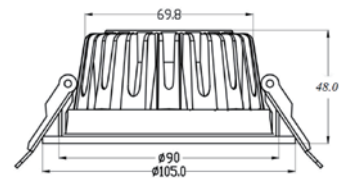

MODEL: DL-A6-4-12W

Power: 12W
Material: Die-casting ALU
Lumens :100lm/w
CRI : 83Ra
SMCM: <3
THD: <15%

Voltage: 200-240Vac
Flicker: Flicker Free
Beam Angle: 110°
CCT: 30K/40K/50K/60K
Optics: Reflector +PC cover
Finish: White

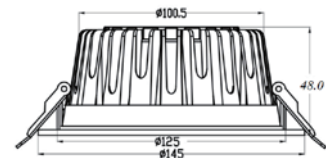

MODEL: DL-A6-5-15W

Power: 15W
Material: Die-casting ALU
Lumens :100lm/w
CRI : 83Ra
SMCM: <3
THD: <15%

Voltage: 200-240Vac
Flicker: Flicker Free
Beam Angle: 110°
CCT: 30K/40K/50K/60K
Optics: Reflector +PC cover
Finish: White



MODEL: DL-A6-6-20W

Power: 20W
Material: Die-casting ALU
Lumens :100lm/w
CRI : 83Ra
SMCM: <3
THD: <15%

Voltage: 200-240Vac
Flicker: Flicker Free
Beam Angle: 110°
CCT: 30K/40K/50K/60K
Optics: Reflector +PC cover
Finish: White

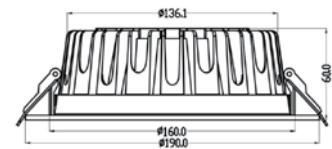

MODEL: DL-A6-8-30W

Power: 30W
Material: Die-casting ALU
Lumens :100lm/w
CRI : 83Ra
SMCM: <3
THD: <15%

Voltage: 200-240Vac
Flicker: Flicker Free
Beam Angle: 110°
CCT: 30K/40K/50K/60K
Optics: Reflector +PC cover
Finish: White

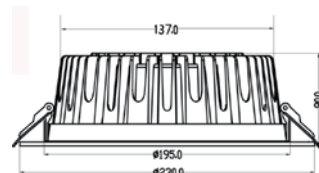

Downlight (A16)



120LM/W

MODEL: DL-A16-3-12W

Power: 12W
Material: Die-casting ALU
Lumens :120lm/w
CRI: 83Ra
SMCM: <3
THD: <15%

Voltage: 200-240Vac
Flicker: Flicker Free
Beam Angle: 90°
CCT: 30K/40K/50K/60K
Optics: Reflector +PC cover
Finish: White

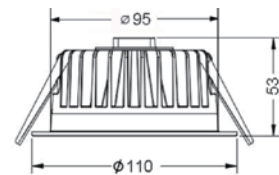

MODEL: DL-A16-4-15W/20W

Power: 15W/20W
Material: Die-casting ALU
Lumens :120lm/w
CRI: 83Ra
SMCM: <3
THD: <15%

Voltage: 200-240Vac
Flicker: Flicker Free
Beam Angle: 90°
CCT: 30K/40K/50K/60K
Optics: Reflector +PC cover
Finish: White

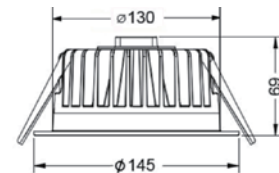

MODEL: DL-A16-6-30W

Power: 30W
Material: Die-casting ALU
Lumens :120lm/w
CRI: 83Ra
SMCM: <3
THD: <15%

Voltage: 200-240Vac
Flicker: Flicker Free
Beam Angle: 90°
CCT: 30K/40K/50K/60K
Optics: Reflector +PC cover
Finish: White

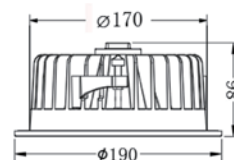

MODEL: DL-A16-8-30W/40W/50W

Power: 30W/40W/50W
Material: Die-casting ALU
Lumens :130lm/w
CRI : 83Ra
SMCM: <3
THD: <15%

Voltage: 200-240Vac
Flicker: Flicker Free
Beam Angle: 90°
CCT: 30K/40K/50K/60K
Optics: Reflector +PC cover
Finish: White

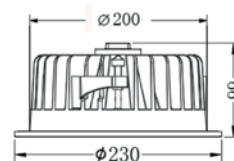

Chip Partners

CITIZEN LUMINUS CREE

Driver Partners

TRIDONIC PHILIPS OSRAM EOXE

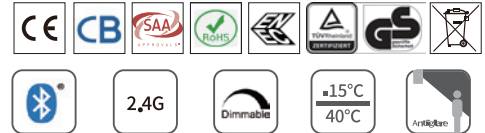

UGR16 Downlight (A22)



UGR16

Chip Partners

CITIZEN  CREE 

Driver Partners

TRIDONIC  OSRAM  EOXE 



MODEL: DL-A22-4-10W/15W

Power: 10W/15W
 Material: Die-casting ALU
 Lumens : 100-120lm/w
 CRI: 83Ra
 SMCM: <3
 THD: <15%

Voltage: 200-240Vac
 Flicker: Flicker Free
 Beam Angle: 70°
 CCT: 30K/40K/50K/60K
 Optics: Reflector +PC cover
 Finish: White/Black

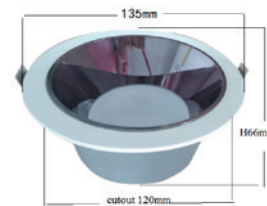

MODEL: DL-A22-6--20W/30W

Power: 20W/30W
 Material: Die-casting ALU
 Lumens :100-120lm/w
 CRI : 83Ra
 SMCM: <3
 THD: <15%

Voltage: 200-240Vac
 Flicker: Flicker Free
 Beam Angle: 70°
 CCT: 30K/40K/50K/60K
 Optics: Reflector +PC cover
 Finish: White/Black

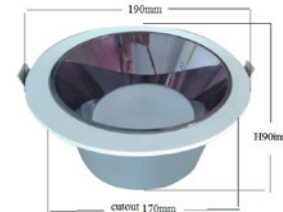

MODEL: DL-A22-8-30W

Power: 30W
 Material: Die-casting ALU
 Lumens :100-120lm/w
 CRI : 83Ra
 SMCM: <3
 THD: <15%

Voltage: 200-240Vac
 Flicker: Flicker Free
 Beam Angle: 70°
 CCT: 30K/40K/50K/60K
 Optics: Reflector +PC cover
 Finish: White/Black

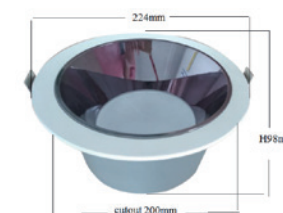

Track Light (X16)



120LM/W



MODEL: TL-X16B-10W

Power: 10W
 Material: Alumium
 Lumens :110-120lm/w
 CRI : >80Ra or >90Ra
 SMCM: <3
 THD: <15%
 Flicker: Flicker Free

Voltage: 200-240Vac 50-60Hz
 Beam Angle: 20° /30° / 45° /60°
 CCT: 27K/30K/40K/50K
 Track: 2/3/4/6wires
 Optics: Reflector
 Finish: White/Black
 Warranty: 5 Years

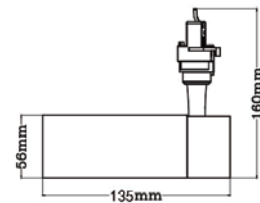

MODEL: TL-X16B-20W/25W

Power: 20W/25W
 Material: Alumium
 Lumens :110-120lm/w
 CRI : >80Ra or >90Ra
 SMCM: <3
 THD: <15%
 Flicker: Flicker Free

Voltage: 200-240Vac 50-60Hz
 Beam Angle: 20° /30° / 45° /60°
 CCT: 27K/30K/40K/50K
 Track: 2/3/4/6wires
 Optics: Reflector
 Finish: White/Black
 Warranty: 5 Years

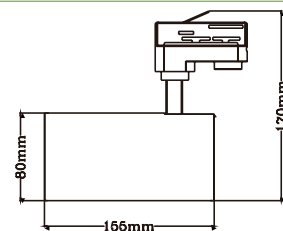

MODEL: TL-X16B-30W/35W

Power: 30W/35W
 Material: Alumium
 Lumens :110-120lm/w
 CRI : >80Ra or >90Ra
 SMCM: <3
 THD: <15%
 Flicker: Flicker Free

Voltage: 200-240Vac 50-60Hz
 Beam Angle: 20° /30° / 45° /60°
 CCT: 27K/30K/40K/50K
 Track: 2/3/4/6wires
 Optics: Reflector
 Finish: White/Black
 Warranty: 5 Years

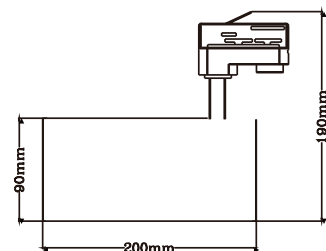

Chip Partners

CITIZEN LUMINUS CREE

Driver Partners

TRIDONIC PHILIPS OSRAM EOXE
 CE CB SAA RoHS

Accessories

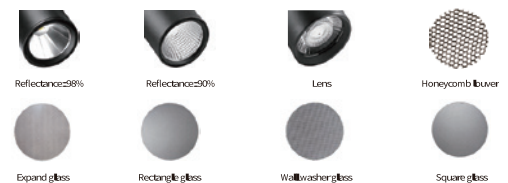

Track Light (C93 & I93)

150LM/W

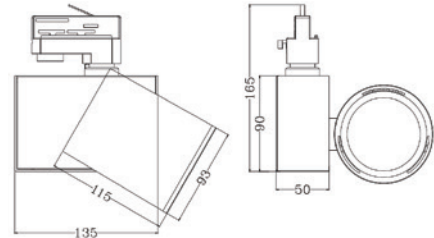

Accessories



Expand glass Rectangle glass Square glass washer glass glass

MODEL: TL-C93-30W/35W

Power: 30W/35W
 Material: Alumium
 Lumens :120,140,150lm/w
 CRI : >80Ra or >90Ra
 SMCM: <3
 THD: <15%
 Flicker: Flicker Free

Voltage: 200-240Vac 50-60Hz
 Beam Angle: 20°/30° / 45° /60°
 CCT: 27K/30K/40K/50K
 Track: 2/3/4/6wires
 Optics: Reflector
 Finish: White/Black/Gray
 Warranty: 5 Years

Chip Partners



Driver Partners



150LM/W

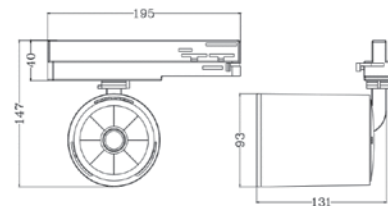

Accessories



Expand glass Rectangle glass Wall washer glass Square glass

MODEL: TL-I93-30W/35W

Power: 30W/35W
 Material: Alumium
 Lumens :120,140,150lm/w
 CRI : >80Ra or >90Ra
 SMCM: <3
 THD: <15%
 Flicker: Flicker Free

Voltage: 200-240Vac 50-60Hz
 Beam Angle: 20°/30° / 45° /60°
 CCT: 27K/30K/40K/50K
 Track: 2/3/4/6wires
 Optics: Reflector
 Finish: White/Black/Gray
 Warranty: 5 Years

Chip Partners



Driver Partners



15-60° Zoomable Track Light (Z92)

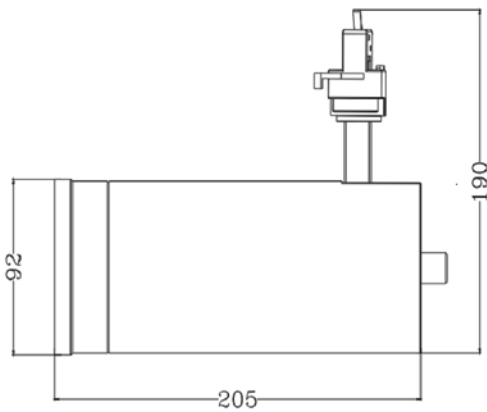

Chip Partners

CITIZEN LUMINUS CREE

Driver Partners

TRIDONIC PHILIPS OSRAM EOXE



MODEL: TL-Z92-30W/35W

Power: 30W/35W
 Material: Alumium
 Lumens : 100lm/w
 CRI : >80Ra or >90Ra
 SMCM: <3
 THD: <15%
 Flicker: Flicker Free

Voltage: 200-240Vac 50-60Hz
 Beam Angle: 20° /30° / 45° /60°
 CCT: 27K/30K/40K/50K
 Track: 2/3/4/6wires
 Optics: Reflector
 Finish: White/Black/Gray
 Warranty: 5 Years

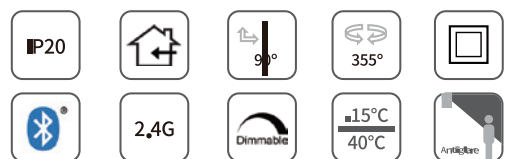

Batten Light (LL-E)



FEATURES

- Flicker Free
- 120lm/w, CRI>80
- SDCM<5
- Patent Design with quick terminal block
Easy to wiring and mount
- CCT selectable, Motion sensor, Emergency
- 5 Years Warranty



Dimming



Emergency



Sensor



Power Selectable



AVAILABLE OPTIONS



Easy to wiring
Easy to Mount



Motion Sensor

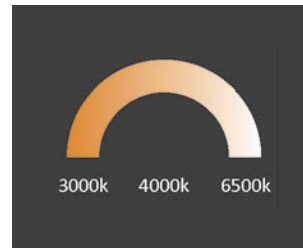

CCT Selectable

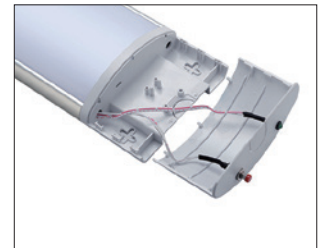

Emergency

PARAMETER

MODEL NO.	LENGTH	POWER	VOLTAGE	BEAM ANGLE	LUMENS	CRI
LL-600-20E	600mm	20W	200-240Vac	120°	100-120lm/w	80+
LL-1200-40E	1200mm	40W	200-240Vac	120°	100-120lm/w	80+
LL-1500-60E	1500mm	60W	200-240Vac	120°	100-120lm/w	80+
LL-1800-72E	1800mm	72W	200-240Vac	120°	100-120lm/w	80+

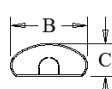
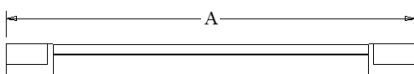

MODEL	A(mm)	B(mm)	C(mm)
2ft/600mm	590	80	36
4ft/1200mm	1190	80	36
5ft/1500mm	1490	80	36
6ft/1800mm	1790	80	36



Batten Light (LL-A)



White color

Silver color

FEATURES

- Flicker Free
- 120lm/w, CRI>80
- SDCM<5
- Ultra Slim , Easy to wiring and mount
- CCT selectable, Motion sensor, WIFI control
- 5 Years Warranty



AVAILABLE OPTIONS

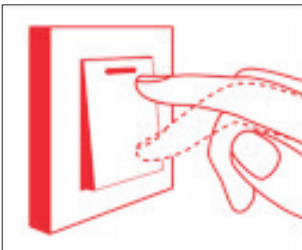

Dimmable by Switch
(100%, 50% and 20%)

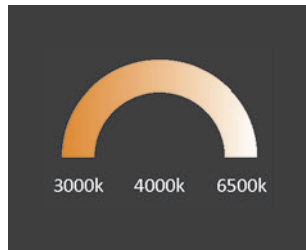

CCT Selectable By Switch
CCT Dimmable by Remote Controller

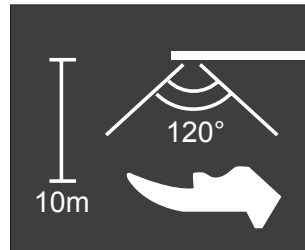

Motion Sensor



WiFi Control
(Distance:150m)

PARAMETER

MODEL NO.	DIMENSION	POWER	VOLTAGE	BEAM ANGLE	LUMENS	CRI
LL600-20A	600mm	20W	200-240Vac	120°	100-120lm/w	80+
LL1200-40A	1200mm	40W	200-240Vac	120°	100-120lm/w	80+
LL1500-60A	1500mm	60W	200-240Vac	120°	100-120lm/w	80+
LL1800-72A	1800mm	72W	200-240Vac	120°	100-120lm/w	80+

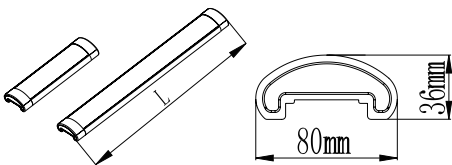

MODEL	L(mm)	B(mm)	C(mm)
2ft/600mm	600	80	36
4ft/1200mm	1200	80	36
5ft/1500mm	1500	80	36
6ft/1800mm	1800	80	36

Linkable Hanging Light (LL-H)



Cover 120° Lens 30° /60° /90°

FEATURES

- Flicker Free
- 120lm/w, CRI>80
- SDCM<5
- Linkable
- CCT selectable, Motion sensor
- Installation: hanging or mounted
- 5 Years Warranty



LINKABLE



PARAMETER

MODEL NO.	DIMENSION	POWER	VOLTAGE	BEAM ANGLE	LUMENS	CRI
LL600-20H	600mm	20W	200-240Vac	30° /60° /90° /120°	120lm/w	80+
LL1200-40H	1200mm	40W	200-240Vac	30° /60° /90° /120°	120lm/w	80+
LL1500-60H	1500mm	60W	200-240Vac	30° /60° /90° /120°	120lm/w	80+

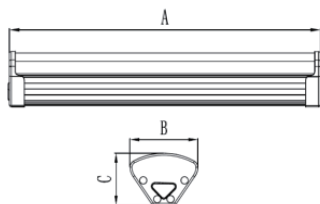

MODEL	POWER	A(mm)	B(mm)	C(mm)
LL600-20H	20W	600	72	54
LL1200-40H	40W	1200	72	54
LL1500-60H	60W	1500	72	54

Linkable Linear Light (LLC)

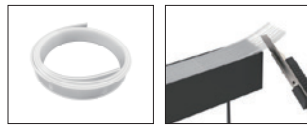
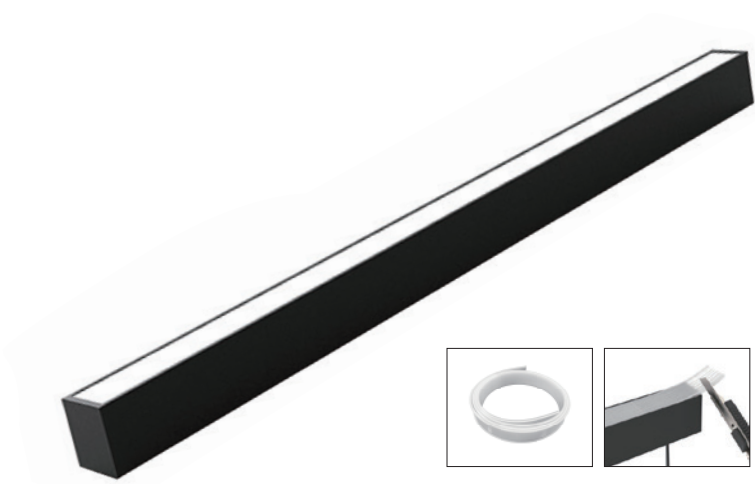

Flexible diffuser (MAX 50M)

FEATURES

- Flicker Free
- 120lm/w, CRI>80
- SDCM<5
- Easy Link, MAX 50M Flexible PC diffuser, Real Seamless



AVAILABLE OPTIONS

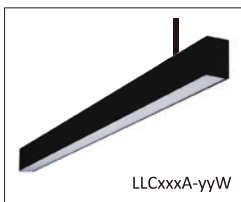

With AC cable,
Use individually or beginning part

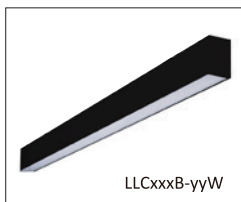

Without AC cable,
Use in multi-connection



✗ Easy handle and tool-free



✗ Easy handle and tool-free



✗ Easy handle and tool-free

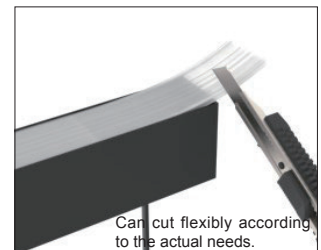
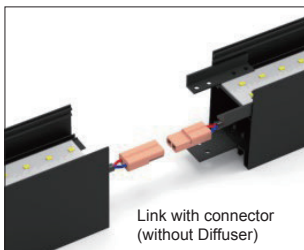

PARAMETER

MODEL NO.	DIMENSION	POWER	VOLTAGE	BEAM ANGLE	LUMENS	CRI
LLC120A/B-40W	1200X50X70mm	40W	200-240Vac	110°	120lm/w	80+
LLC150A/B-50W	1500X50X70mm	50W	200-240Vac	110°	120lm/w	80+
LLC1616L-10W	165x165x(50x70)mm	10W	200-240Vac	110°	120lm/w	80+
LLC3116T-15W	310x165x(50x70)mm	15W	200-240Vac	110°	120lm/w	80+
LLC3131X-20W	310x310x(50x70)mm	20W	200-240Vac	110°	120lm/w	80+

Linkable Linear Light (LLD)



UGR<16

FEATURES

- Flicker Free
- >110lm/w, CRI>80, SDCM<5
- Anti-Glare, UGR<16
- Beam Angle: 60°/35°/2x20°/97° optional
- Seamless Connection, Power Up To 2200W
- OSRAM LED chips, OSRAM Driver
- 5 Years Warranty



AVAILABLE OPTIONS



With AC cable, Use individually or beginning part



Without AC cable, Use in multi-connection



Easy handle and tool-free



Easy handle and tool-free



Easy handle and tool-free

PARAMETER

MODEL NO.	DIMENSION	POWER	VOLTAGE	BEAM ANGLE	LUMENS	CRI
LLD120A/B-40W	1200x41x68mm	40W	200-240Vac	35°/60°/97°/2x20°	120lm/w	80+
LLD150A/B-50W	1200x41x68mm	50W	200-240Vac	35°/60°/97°/2x20°	120lm/w	80+

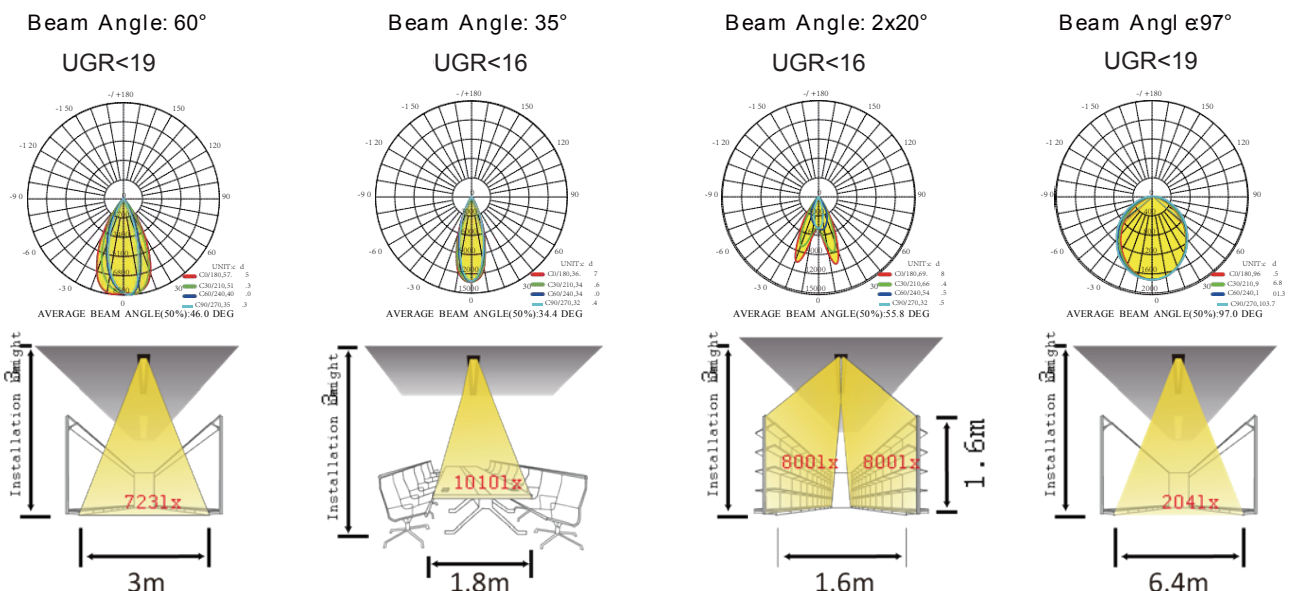



Shenzhen CGT Technology Co.,Ltd



Add: No.11,YuanHu Road Zhangbei Industrial Park,
Longgang District,Shenzhen,China



+86(0)755/2236 1751



info@cgtled.com



www.cgtled.com



<http://cgttech.en.alibaba.com/>