



VERO GLOBAL COMMUNICATION CO.,LTD

Address: Quanzhou Economic and Technological Development Zone, Fujian Province

E-mail: info@verotelecom.com

Web: <http://www.verotelecom.com>



VERO INTELLECTUAL CREATION

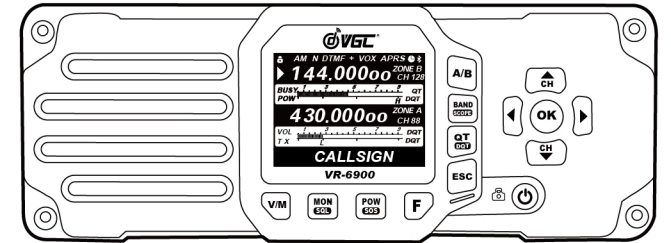

VHF & UHF Dual Band FM Transceiver

VR-6900

USER'S MANUAL



USER

Thank you for **VGCL**® wireless communication device from Winotech. Weinuozi has made HAM enthusiasts have full-featured, cost-effective and maintainable radio communication equipment. We will continue to introduce a variety of new radio communication equipment to meet the needs of the majority of HAM enthusiasts.

PLACARD

The Regulations of the People's Republic of China on Radio Regulations stipulates that units and individuals that set up and use radio transmissions within the territory of the People's Republic of China must apply to the corresponding radio regulatory agency for the establishment of a station and obtain a radio license before they can use it.

Contents

Standard & Optional Accessories	01	Basic operation	17
Standard Accessories	01	Frequency mode and channel mode switching	17
Optional Accessories	01	Delete channel	17
Installation	02	Sub-audio setting	17
Preliminary inspection	02	Emergency rescue channel mode	18
Installation skills	02	Spectrum mode	18
Security Information	02	Quickly adjust the frequency	18
DC power cable connection	03	PTT follow function	18
Radio and power connection	03	Restore menu settings	18
Fixed station operation	04	Reset	18
Replace the fuse	04	Menu function setting	19
Antenna connection	04	Display	19
Important notes on car radio operation	05	Transmit/receive	20
control panel	06	Memory	21
Control panel bracket mounting	08	Scanning	22
Panel to host connection	09	System	23
Hand microphone button and definition	10	Signaling	24
Host	11	APRS function	24
Host and panel integrated connector	13	Bluetooth function	25
Front panel control buttons and switches	14	Evice Information	25
Screen description	15	Technical specifications	26
Smart shortcut	16		

Quasi-accessories & Accessories

Standard accessories

DTMF Multi-functions Microphone(HM-68)	1
Mobile Mounting Bracket for Rear Chassis(MMB-69B) ---	1
DC power cable (2.5 level)	1
Control Cable(short)	1
Spare fuse (15A, 32V)	1
Screws	1
Microphone Bracket	1
VR-6900 User Manual	1

Optional accessories

Mobile Mounting Bracket for Front Panel	MMB-69A
Control Cable (5 meters)	CAB-5
Bluetooth TNC & GPS & APRS Component	BTG-6900A2
Programming Cable	VPG-6900
High-power external speaker	ESP-69
Repeater Function Control Cable	RPC-69
Control Panel Handle	FPH-69

INSTALLATION

This chapter describes the installation procedure for integrating the transceiver into a typical amateur radio station. It is presumed that you possess technical knowledge and conceptual understanding consistent with your status as a licensed radio amateur. Please take some extra time to make certain that the important safety and technical requirements detailed in this chapter are followed closely.

PRELIMINARY INSPECTION

Inspect the transceiver visually immediately upon opening the packing carton. Confirm that all controls and switches work freely, and inspect the cabinet for any damage. Gently shake the transceiver to verify that no internal components have been shaken loose during shipping.

If any evidence of damage is discovered, document it thoroughly and contact the shipping company (or your local dealer, if the unit was purchased over-the-counter) so as to get instructions regarding the prompt resolution of the damage situation. Be certain to save the shipping carton, especially if there are any punctures or other evidence of damage incurred during shipping. If it is necessary to return the unit for service or replacement, use the original packing materials. Then put the entire package inside another packing carton to preserve the evidence of shipping damage for insurance purposes.

INSTALLATION TIPS

To ensure long life of the components, be certain to provide adequate ventilation around the cabinet of the transceiver.

Do not install the transceiver on top of another heat-generating device (such as a power supply or amplifier) and in a location exposed to dust and/or high humidity. Avoid heating vents and window locations that could expose the transceiver to excessive direct sunlight, especially in hot climates. This transceiver should not be used in an environment where the ambient temperature exceeds +140 °F (+60 °C).

 This transceiver is designed for a 13.8 V power source. Never use a 24 V battery to power the transceiver.

 The vehicle battery must have a nominal rating of 12 V. Never connect the transceiver to a 24 V battery. Be sure to use a 12 V vehicle battery that has sufficient current capacity. If the current to the transceiver is insufficient, the display may darken during transmission, or transmit output power may drop excessively.

 If you use the transceiver for a long period when the vehicle battery is not fully charged, or when the engine is OFF, the battery may become discharged, and will not have sufficient reserves to start the vehicle. Avoid using the transceiver under these conditions.

 Transmitting without first connecting an antenna or other matched load will damage will transceiver. Always connect the antenna to the transceiver before applying power or transmitting.

This transceiver is an electrical apparatus, as well as a generator of High RF (Radio Frequency) energy. You should exercise all safety precautions that are appropriate for this type of device. These safety tips apply to any device installed in a well-designed amateur radio station.

- ⚠ Never allow unsupervised children to play in the vicinity of your transceiver or antenna installation.
- ⚠ Be certain to wrap any wire or cable splices thoroughly with insulating electrical tape, to prevent short circuits.
- ⚠ Do not route cables or wires through doorjamb or other locations where they may become frayed and shorted to ground or to each other.
- ⚠ Do not stand in front of a directional antenna while you are transmitting into that antenna.
- ⚠ Do not install a directional antenna in any location where humans or pets may walk in the main directional lobe of the antenna's radiation pattern.
- ⚠ In mobile installations, it is preferable to mount the antenna on top of the vehicle, if feasible, this will utilize the car body as a counterpoise and raise the radiation pattern as far away from passengers as possible.

- ⚠ During mobile operation when stopped (in a parking lot, for example), make it a practice to switch to Low power if there are people walking nearby.
- ⚠ Never wear dual-earmuff headphones while driving a vehicle.
- ⚠ Do not attempt to drive your vehicle while making a telephone or auto patch call.
- ⚠ While using the optional DTMF microphone. Pull over to the side of the road, whether dialing manually or using the auto-dial feature.
- ⚠ Do not connect the modular connector of the telephone line to MIC jack.
- ⚠ **Warning!:** High RF voltage is present in the TX RF section of the transceiver while transmitting. Do not touch the TX RF section while transmitting.

CONTROL PANEL

Front Side

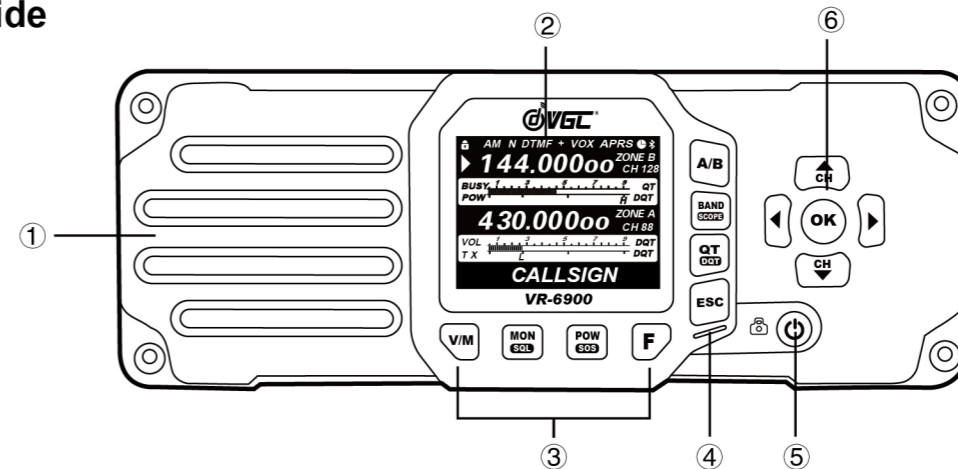

- ① Panel loudspeaker
- ② TFT color screen
- ③ Multi-function keys and combination shortcut keys
- ④ TX/RX indicator light
- ⑤ Power Switch

- ⑥ Directional navigation/confirmation key
- ※: The four holes around the panel are fixed holes for panel handle, which can be used to install the optional FPH-69 handle or for the installation of embedded control panel.

CONTROL PANEL

Back Side

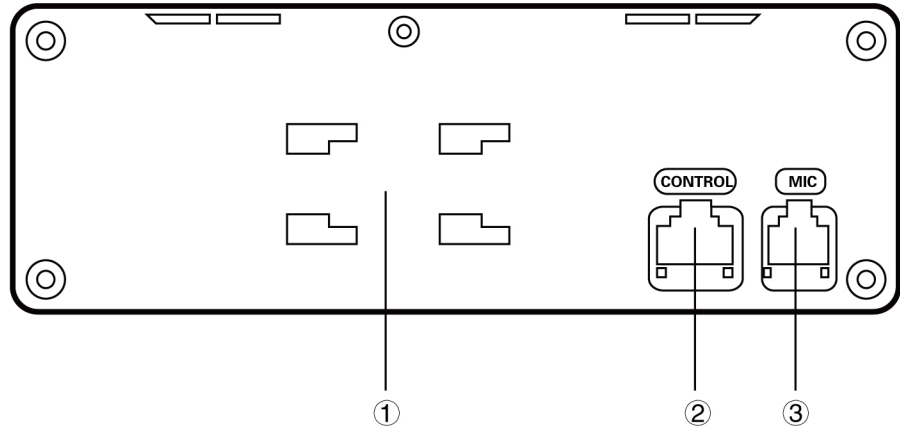

① Mounting Bracket Connector

② Control Cable Connector

③ Speaker Microphone Connector

CONNECTING BETWEEN MAIN TRANSCEIVER AND PANEL

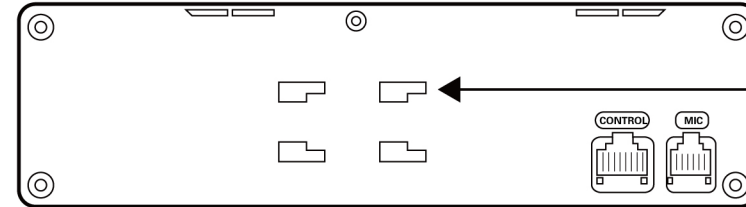

Mounting Bracket Connector

1. Inserted into the connector
2. Slide to the left

A: Screw

B: Unscrew

(Adjust the tightness of rotation by A/B)

C: Unlock

D: Lock

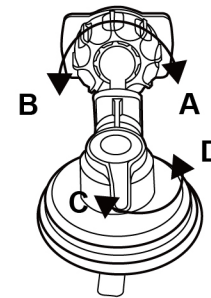

The newly designed 360 degree suction cup mounting bracket allows for superior suction and durability in the roughest environments. The bracket also allows you to remove the display for use or storage when required. All without the use of permanent mounting screws.

CONNECTING BETWEEN MAIN TRANSCEIVER AND PANEL

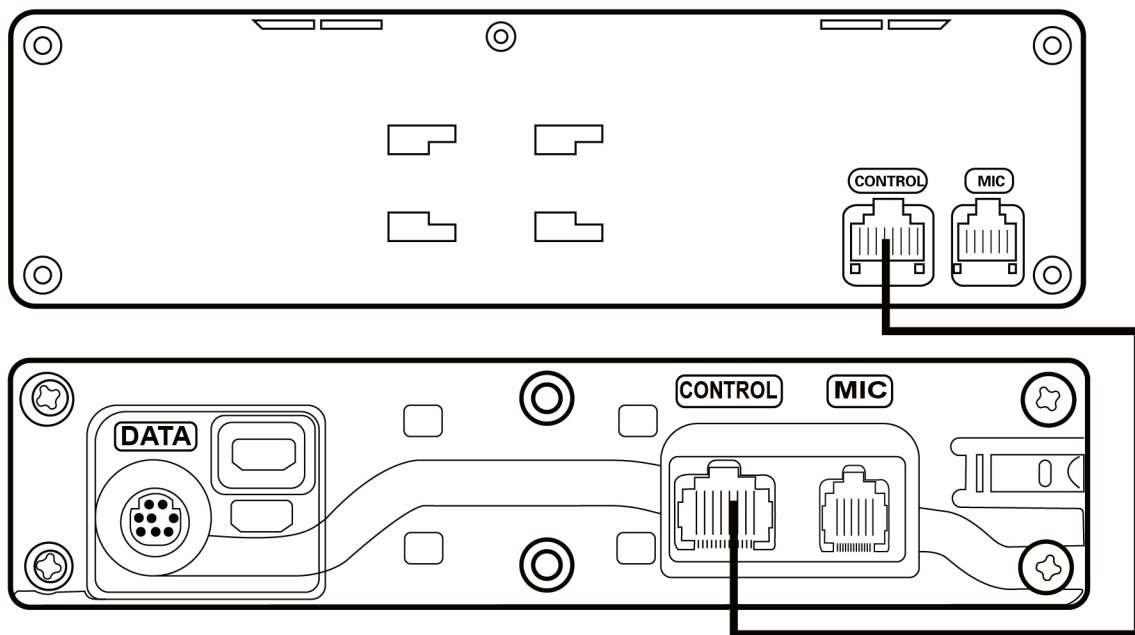

Control line

MEMORY EDIT

The memory channels may be edited using Set Mode item "D02 MEMORY EDIT" in the "MEMORY" group.

LABELING MEMORIES

1. Rotate the leftside [DIAL] knob to select a memory channel to append or change the label.
2. Press the [V/M] key for two seconds, and then append or change the label in the same manner as step 2 of the "Memory Storage" procedure (see page 7).

COPYING MEMORIES

1. Rotate the leftside [DIAL] knob to select the memory channel to be copied.
2. Press the [SEL] key
3. Rotate the leftside [DIAL] knob to select a memory channel to store the data.
4. Press the [CPY] key to copy the memory channel data.
5. Press the [SEL] key to save the data.

DELETING MEMORIES

1. Rotate the leftside [DIAL] knob to select the memory channel to delete.
2. Press the [SEL] key.
3. Press the [DEL] key to delete the memory channel data.

※: Do not use any cables or accessories which are not made in VERO, otherwise it may damage the radio.

HAND MICROPHONE BUTTON AND DEFINITION

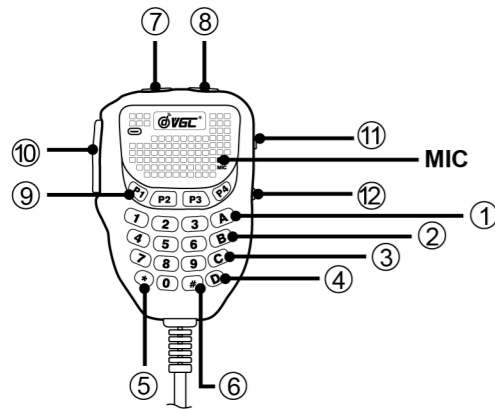

- ① **【A】** key, Channel mode & Frequency mode switch
- ② **【B】** key, Band switch
- ③ **【C】** key, Confirm key
- ④ **【D】** key, Delete key
- ⑤ **【*】** key, Volume down
- ⑥ **【#】** key, Volume up
- ⑦ **【DOWN】** key, Freq. Channel, meun etc. adjusted downwards. Long press to adjust continuously.
- ⑧ **【UP】** key, Freq. Channel, meun etc. adjusted upwards. Long press to adjust continuously.
- ⑨ **【P1】 【P2】 【P3】 【P4】** key, Customized shortcut keys(Set in the Menu)
- ⑩ **【PTT】** TX key
- ⑪ **【LOCK】** key, Lock the keypad of MIC by pulling up, unlock the keypad of MIC by pulling down (PTT still works)
- ⑫ **【LAMP】** Turn on the light of keypad by pulling up, turn off the light of keypad by pulling down.

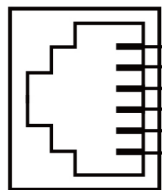

A:PTT
B:MIC
C:GND
D:DC 5V
E:SW1
F:SW2

Hand Microphone Socket Definition

※: Hand microphone number key uses the intelligent Chinese input method to input Chinese and English characters. Input method You can switch the input method format by pressing the [B] key.

MAIN TRANSCEIVER

Front Side

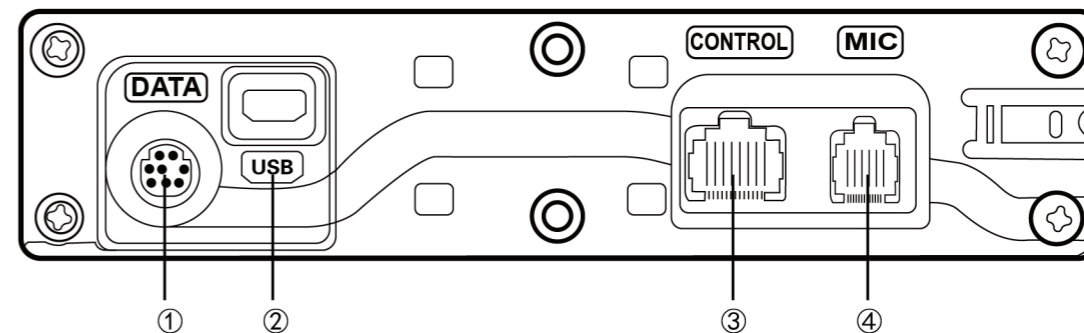

※: Do not use any cables or accessories which are not made in VERO, otherwise it may damage the radio.

① **Programming Cable Connector**

② **USB Connector**

③ **Control Cable Connector**

④ **Speaker Microphone Connector**

FRONT PANEL CONTROL BUTTONS AND SWITCHES

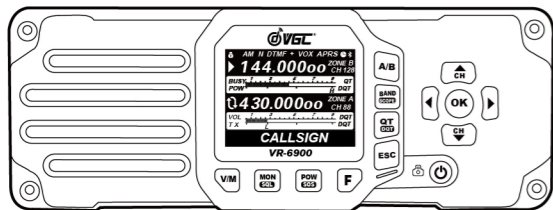

- A/B key**
Short press: A/B main band switch
Long press: single/dual band mode switch
- BAND key**
Short press: frequency switch Long press: no function
- QT key**
Short press: no function
Long press: Set QT/DQT for the current freq. / channel
- ESC key**
Short press: Exit
- VIM key**
Short press: Fre. Mode & channel mode switch
Long press: Save the current frequency into channel
- MON key**
Short press: no function Long press: turn on the SQL function
- POW key**
Short press: H/M/L output power switch

Long press: No function

8、F key

Short press: Press 【F】 key + oether key to achieve shortcut function

Long press: No function

9、CR key

Press to raise the operating frequency, Memory Channel number, Menu Number, etc. Hold down to repeat the action. Also press to switch between values for functions with multiple choices.

10、CH key

Press to lower the operating frequency, Memory Channel number, Menu Number, etc. Hold down to repeat the action. Also press to switch between values for functions with multiple choices.

11、V key

Short press(In standby status): - volumn

Long press(In standby status): + volumn continuously

※: Set volumn separately for A/B band. When adjust the volumn to be 0(mute status), a mute icon will appear on the screen and display.

12、> key

Short press(In standby status): - volumn

Long press(In standby status): + volumn continuously

※: Set volumn separately for A/B band.

13、Ⓛ key

Short press: Lock/unlock the keypad

(The lock icon will be appeared when lock)

Long press: Power on/off

SCREEN DESCRIPTION

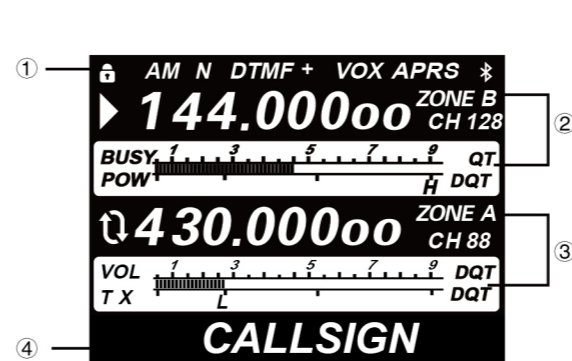

- A/B band function Icon display area
- A band frequency display area
- B band frequency display area
- Callsign/name display area

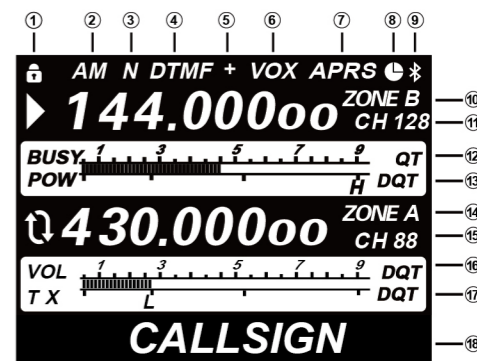

- Keypad lock icon
- AM icon
- Narrow band icon
- DTMF icon
- RPT shift frequency icon
- VOX icon
- APRS icon
- APO (Automatic power-off time) icon
- Bluetooth Mic icon
- A band zone
- A band channel icon
- A band QT icon
- A band DQT icon
- B band zone
- B band channel icon
- B band QT icon
- B band DQT icon
- Callsign/Name display

MAIN TRANSCEIVER

Back Side

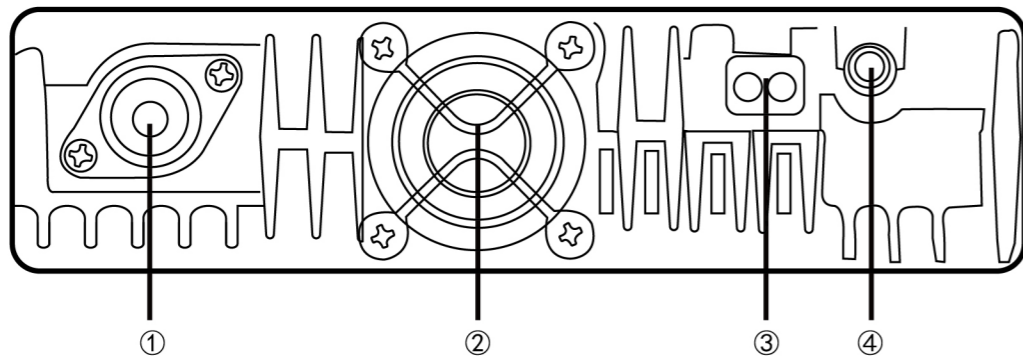

① Antenna connector

② Cool fan(Select 3 modes in the menu)

③ 13.8V DC power supply connector

④ External loud speaker connector

HOST AND PANEL INTEGRATED CONNECTOR

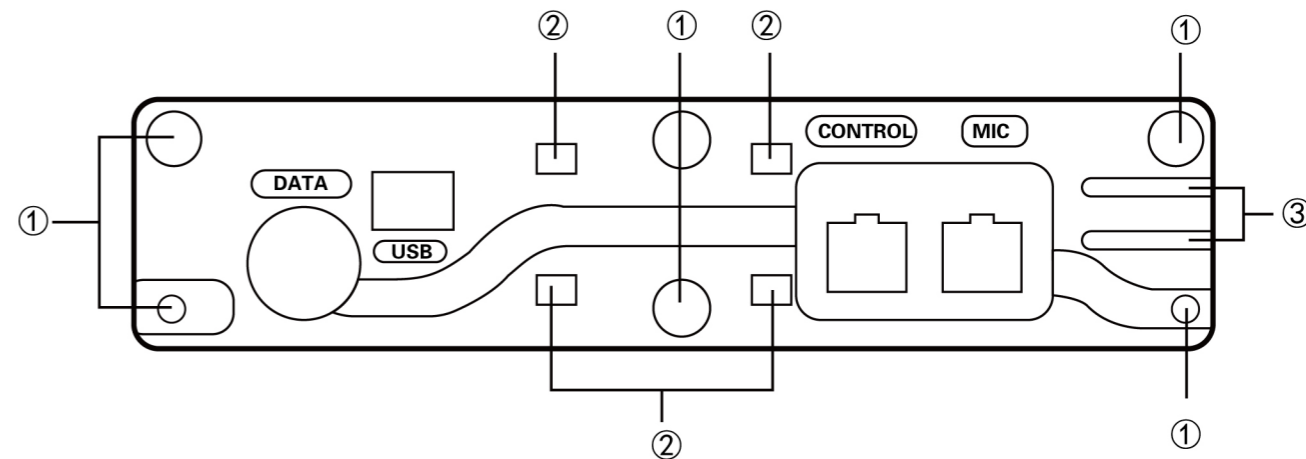

① Screws hole

② Plastic buckle

③ Unlock butto

Used to open the connection of the panel to the main transceiver

SHORTCUT KEY

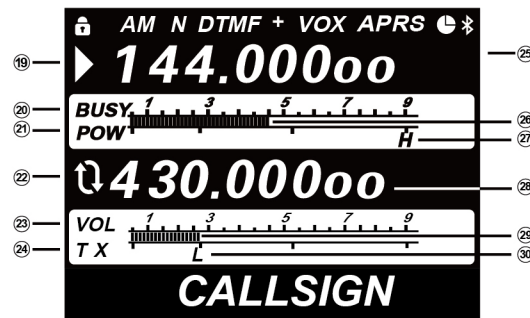

- ①⑨ Main band icon
- ②⑩ A band BUSY icon(Be VOL icon when adjust the volumn in A band)
- ②① A band power icon
- ②② PTT follow function icon
- ②③ B band volumn icon(Be BUSY icon when not adjust the B band volumn)
- ②④ B band TX iconTX(Be POW icon when not TX B band)
- ②⑤ A band frequency display
(Channel number/name dispaly when in channel mode)
- ②⑥ A band RX signal strength display
(Be volumn strength display when adjust the volumn in A band)
- ②⑦ A band power level icon(H:High, M: Middle, L: Low)
- ②⑧ B band frequency dispaly
(Channel number/name dispaly when in channel mode)
- ②⑨ B band TX power dispaly
(Be volumn strength display when adjust the volumn in B band)
- ③⑩ B band outpower level icon(H:High, M: Middle, L: Low)

SHORTCUT KEY

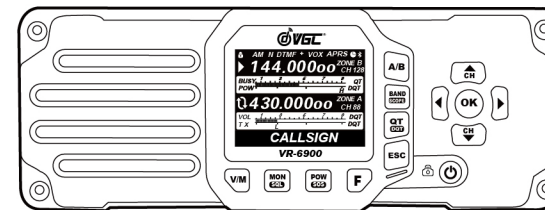

- F** key+ **A/B** key: APRS funtion, press **ESC** key to exit
- F** key+ **BAND** key: SCOPE function, press **ESC** key to exit
- F** key+ **CH** key: In RX status, turn-on the QT function, press **ESC** key to exit
- F** key+ **V/M** key: Enefer zone A/B/C/D, press **CH** **CH** to select, then press **OK** to confirm.
- F** key+ **MON** key: SQL setting, press **CH** **CH** key then press **OK** to confirm.
- F** key+ **POW** key: Enter SOS mode, press **F** key+ **POW** again to exit.
- F** key+ **CH** key: Scan up the channel/frequency, press **ESC** key to exit.
- F** key+ **CH** key: Scan down the channel/frequency, press **ESC** key to exit.

BASIC OPERATION

Quickly Save Channel

- 1、 In frequency mode, typing the frequency.
 - 2、 Long press **[V/M]**, there are memory zone A/B/C/D on the screen, press **[CH]** **[CH]** key to select.
 - 3、 Press **[OK]** key, there are 3 options on the screen, one is BOTH (save this freq. as same TX/RX), second one is RX(Save this freq. as RX freq.) or third one TX(Save this freq. as TX freq.), then press **[OK]**.
 - 4、 Press **[CH]** **[CH]** key to select the channel number, press **[OK]** key to save and it will automatically back to the current freq. Mode. (Short press [V/M] to enter channel mode, press **[CH]** **[CH]** to select the channel in the current zone.
- ※ : While saving the channel, it will automatically jump to the blank channel in some zone, black number on the left is the stored channel number, red number on the right is the blank channel number. Press **[CH]** **[CH]** to check all channels in this area.

Channel mode and frequency mode Switch

In frequency Or Channel mode, short press **[V/M]** key to enter channel mode or frequency mode.

※ : In the freq.(channel) mode, short press **[CH]** **[CH]** to change the current

freq.(channel). Long press **[CH]** **[CH]** to change the current freq.(channel) continuously.

Channel name edit

In the channel mode, select the channel, press **[OK]** key to enter menu.

Press **[CH]** **[CH]** to select [3-MEMORY] and press **[OK]** to enter.

Press **[CH]** **[CH]** to select [3-2 MEMORY EDIT] and press **[OK]** to enter.

Typing the name via microphone then press **[OK]** to save.

※ : If you need to edit a large number of channel names, you can edit then on the programming software.

Channel delete

In the channel mode, select the channel, press **[OK]** key to enter menu.

Press **[CH]** **[CH]** to select [3-MEMORY] and press **[OK]** to enter.

Press **[CH]** **[CH]** to select [3-7 MEMORY DELETE] and press **[OK]** to enter.

Press **[OK]** key again to delete the current channel.

QT setting

Select frequency or channel, long press **[QT]** key, then press **[CH]** **[CH]** to select " RX_CTCSS/RX_DCS/TX_CTCSS/TX_DCS", press **[OK]** key to enter

the list. Setting the CTCSS/DCS via press **[CH]** **[CH]**, last press **[OK]** key to save. If there is no other need, press **[ESC]** to exit. (There is QT icon after setting).

※ : Typing the CTCSS/DCS on microphone directly. (e.g. CTCSS 79.4, press [0] [7][9][4], then press **[OK]** or [C] on the microphone to save.

SOS Channel Mode

Press **[F]** + **[POW]** to enter the set SOS frequency/channe. You can only adjust power and volumn in SOS mode, other functions cannot be changed.

Press **[F]** + **[POW]** to exit.

※ : This feature is set up according to the actual situation and very helpful in an emergency situation.

SCOPE Mode

Press **[F]** + **[BAND]**. This function can realize a variety of dynamic spectrum search modes, and search for real-time signal status of surrounding frequencies and channels anytime and anywhere. Press **[ESC]** to exit this mode.

※ : The specific spectrum mode should be preset in the menu.

Adjust Frequency Continuously

In frequency mode, long press **[OK]** for 3 seconds, the Mega digit will flash, short press **[CH]** **[CH]** key to adjust in 1M step, long press **[CH]** **[CH]** key to adjust frequency continuously.

PTT Follow Function

The screen shows **[PTT]** icon after setting this function in the menu. At this time, regardless of whether the main band is in A band or B band, as long as any band has a signal coming in, directly press PTT to transmit at the band where the signal is received. If the sub-band signal comes in, the PTT will be transmitted in the sub-band; the main band signal comes in, and the PTT will be transmitted in the main band (the regular PTT can only be transmitted in the main band).

※ : This function is mainly used for the case where the A/B main and sub-sband are frequently transmitted, and it is not necessary to switch to the main band every time before transmitting.

Restore Menu Setting

Enter menu [5-SYSTEM]/[5-8 BAND RANGE SET], typing '870104'to restore the menu setting.

※ : This function only restores the set menu without changing the original frequency/channel data of the radio.

Restore Factory Defaults

Enter menu [5-SYSTEM]/[5-8 BAND RANGE SET], typing '870105'to restore the factory setting.

※ : This funtion will recovstore all datas to factory settings. Back up the current frequency/channel data before this operation.

Menu setting

■ DISPALY

● 1-1 SELECT LANGUAGE

- SIMPLIFIED CHINESE
- ENGLISH

● 1-2 POWER ON MESSAGE

- OFF
- ON

● 1-3 USER NAME

- OFF
- ON

● 1-4 BATTERY VOLTAGE

- OFF
- ON

● 1-5 LCD BRIGHTNESS

- 1/2/3...8 brightness level.

● 1-6 KEY PAD LIGHT

- OFF
- ON

● 1-7 LOGO LIGHT

- OFF
- ON

● 1-8 APO SET

- OFF
- 0.5/1.0/1.5/2.0/2.5/3.0H sleep timer

※: The  icon will be displayed when the timed shutdown function is turned on. The timed shutdown function will count down when you last press the keyboard. If any keyboard is operated after startup, the timer will restart counting down.

■ TX/RX

● 2-1 MIC GAIN

- The [MIN/LOW/NORMAL/High/MAX] level can be set according to actual needs.

● 2-2 RPT SHIFT DIREC

- SHIFT OFF
- SHIFT -
- SHIFT +

● 2-3 RPT SHIFT FREQ

- Type the shift freq. Via microphone keypad.

● 2-4 BAND PRESET

- A、B band can be set independtly to be single or muti bands.

78-108MHz



108-136MHz

136-174MHz

350-400MHz

400-480 MHz

480-520MHz

※: Pressing the  keybutton after selecting the band will not display the unselected band. If the single 136-174 MHz band is selected in section A, then segment A is a single 136-174 MHz band. Pressing the  button will not switch to other unselected bands. If you select multiple bands, press the  button to switch between the selected bands.

● 2-5 VOX

- OFF

Front HAND-MIC: Connect MIC to the panel to achieve VOX

REAR HAND-MIC: Connect MIC to the main transceiver to achieve VOX

※: Do not turn on this function if no need.

● 2-6 VOX sensitivity

- The [MIN/LOW/NORMAL/High/MAX] level can be set according to actual needs.

● 2-7 AUTO/WIDE/NARROW/AM

AUTO(WIDE FM 25KHZ)

Wide FM 25KHz

Narrow FM 12.5 KHz

AM

※: This option is effective for the currently selected band. Not for all bands. Generally, the default selection is AUTO, do not set at will.

● 2-8 FAN ACTION

CONTINUOUS

TEMPERATURE+PTT: Active the fan when the main transceiver reaches a certain temperature or when the PTT button is pressed.

TEMPERATURE: Active the fan when the main transceiver reaches a certain temperature

● 2-9 PTT MODE

GENERAL

FOLLOW(PTT FOLLOW RX)

※: The screen shows  icon after setting this function in the menu. At this

time, regardless of whether the main band is in A band or B band, as long as any band has a signal coming in, directly press PTT to transmit at the band where the signal is received. If the sub-band signal comes in, the PTT will be transmitted in the sub-band; the main band signal comes in, and the PTT will be transmitted in the main band (the regular PTT can only be transmitted in the main band).

This function is mainly used for the case where the A/B main and sub-band are frequently transmitted, and it is not necessary to switch to the main band every time before transmitting.

■ MEMORY



●3-1 DISPLAY

- FREQ+CHANNEL
- CHANNEL
- CHANNEL NAME

●3-2 CHANNEL EDIT

- Typing the channel name via microphone and press **OK** to save.

●3-3 MEMORY SOS CHANNEL

- FREQUE EDIT (Press   to switch TX/RX, typing the frequency via microphone then press **OK** to save.
- QT_DQT SET
- WN SET

●3-4 MEMORY SCAN TYPE

- ALL MEMORY
- SELECT MEMORY



●3-5 MEMORY SKIP/SELECT

- OFF
- SKIP: The current memory channel is set to scan the "skip" channel. The current channel position displays the "▲" icon.
- SELECT: The current memory channel is set to scan the "select" channel. The current channel position displays the "■" icon.

●3-6 MEMORY ZONE

- ZONE A
- ZONE B
- ZONE C
- ZONE D

●3-7 CHANNEL DELETE

- Delete the channel via   on the panel or on the MIC then press **OK** to confirm.

■ SCAN

●4-1 DUAL WATCH STOP

- AUTO: When the priority channel receives a signal, the dual-frequency monitoring function will stop. When the signal is attenuated, the dual frequency monitor will restart.
- HOLD: When the priority channel receives a signal, the dual-frequency monitoring function will stop. And it won't restart automatically.









●4-2 SCAN RESUME

- BUSY: The scan will stop when it encounters a signal. After the signal is attenuated, the scan restarts.
- HOLD: The scan will stop when it hits the signal. And it won't restart automatically.
- TIME 1 sec: The scan stops when it hits the signal, and the scan restarts after 1 second.
- TIME 3 sec: The scan stops when it hits the signal, and the scan restarts after 3 second.
- TIME 5 sec: The scan stops when it hits the signal, and the scan restarts after 5 second.

●4-3 SCAN STOP BEEP

- OFF
- ON

●4-4 PROPRITY CHANNEL

- PROPRITY CHANNEL 1: Enter this option, select the priority channel to be set in the current channel area through the panel CH   key or hand microphone  , press **OK** to confirm.
- PROPRITY CHANNEL 2: Enter this option, select the priority channel to be set in the current channel area through the panel CH   key or hand microphone  , press **OK** to confirm.

●4-5 BAND SCOPE MODE

- FREQUE: Search the spectrum by current frequency.
- BAND: Search by the current frequency band with spacing 0.5M/1.0M/1.5M...10M
- CH: Search the spectrum by current channel.
- ※: This spectrum function will be much helpful in some special occasions.

■SYSTEM

●5-1 TO STEP

○SET 2.5KHz/5 KHz/6.25 KHz/...100.00 KHz/ for the current frequency

●5-2 BEEP

○OFF

○HIGH

○LOW

●5-3 MIC P KEY

○P1

○P2

○P3

○P4

※: This function will customize the P1/P2/P3/P4 shortcut function keys on the hand microphone.

●5-4 OPERATION MODE

○OFF

○ON

※: This radio uses a microprocessor to control various functions, so some times the CPU clock oscillator may have slight interference with the

receiving frequency. In this case, the beat frequency shift function can be turned on.

●5-5 RX COVERAGE

○VFO

In the frequency band: Circle within the frequency range.

Full band: Circle over all frequency bands.

※: If the frequency is selected in the frequency mode: When the VFO frequency is adjusted to the highest frequency of the current zone, the VFO frequency will jump to the lowest frequency of the current zone.

If the full band is selected in the frequency mode: when the VFO frequency is adjusted to the highest frequency of the current zone, the VFO frequency will jump to the lowest frequency of the next zone.

○MEMORY

In the frequency band: Circle within the frequency range.

Full band: Circle over all frequency bands.

※: If the frequency band is selected in channel mode: Only memory channels in the same zone of the current memory channel can be used.

If the full band is selected in channel mode: All channels in any zone can be used.

●5-6 TOT

○OFF

○1 min/3/5/.../13/15 mins

●5-7 FRONT SPEAKER

○OFF

○ON

●5-8 BAND RANGE SET

○Input password to restore menu setting

○Input password to restore factory setting

●5-9 REPEATER

○OFF

○ON

※: A repeater control cable is required to enable this function.

■SIGNALING

●6-1 DTMF MODE

○OFF

○ON

●6-2 DTMF ENCODE MEMORY

○Editable 9 DTMF CODES

●6-3 SQL TAIL ELIMINATION

○OFF

○120 DEGREES 180ms

○180 DEGREES 160ms

※: The SQL tail elimination of both parties must be consistent.

●6-4 COURTESY TONE(TX BEEP)

○OFF

○SEND FRONT: (Before transmitting)

○SEND BEHIND:(After transmitting)

○BOTH

■ APRS function

※: This function requires BTG-6900A2 bluetooth component to be used.

● 7-1 POWER-SW

- OFF
- ON

● 7-2 DATA BAND SELECT

- DATE: BAND A
- DATE: BAND B

● 7-3 APRS_SET

- Callsign
- ※: Max.9 characters to input the callsign, and enter letters to capitalize.
The call sign suffix "-X" indicates the SSID (slave station identifier),16 types in total, including one without SSID, as shown in the following table.
- APRS Message Text
 - My Symbol
 - APRS Reset
 - SmartBeaconing
 - TX Interval(Factory Default)
 - TX Delay(Factory Default)
 - Message Show
 - TIME ZONE

■ BLUETOOTH

- OFF
- ON

※: This function requires the optional bluetooth component from VERO to be used.

■ VERSION

- MAIN VERSION
- PANEL VERSION

TECHNICAL SPECIFICATIONS

General	
Frequency Range:	RX: 76-108MHz (FM Radio) 108-136MHz (Air Band) 136-173.995MHz (144MHz HAM Band) 350-400MHz (General 1) 400-479.995MHz (430MHz HAM Band) 480-520MHz (General 2) TX: 136-173.995MHz(HamBand) 222-225 MHz (USA version only) 430-479.995MHz (Ham Band)
Channel Step:	2.5, 5, 6.25, 10, 12.5, 15, 20, 25, 50, 100, 200KHz.
Frequency Stability:	± 2.5ppm (+14°F to +140°F [-10°C to +60°C])
Repeater Shift:	±600KHz (144MHz) ±1.6 / 5.0 / 7.6 MHz (430MHz)
Emission Type:	F1, F2, F3
Antenna Impedance:	50 Ω
Supply Voltage:	Nominal: 13.8V DC, Negative Ground Operating: 11.7 - 15.8V, Negative Ground
Current Consumption:	0.5A (Receive) 10A (TX, 144 MHz 50W) 12A (TX, 430 MHz 50W)
Operating Temperature:	-4°F to +140°F (-20°C to +60°C)
Case Size (WxHxD):	Panel: 6.3" x 2.6" x 1.3" (157 x 66 x 33.5 mm) Panel w/o knob connectors Panel: 5.5" x 1.8" x 6.0" (140 x 46 x150mm) Panel w/o knob connectors
Weight (Approx)	2.3 lbs (1.05kg) Rear Chassis.

Transmitter	
RF Power Output:	45W / 20W / 5W (Approx)
Modulation Type:	Variable Reactance F1, F2, F3
Maximum Deviation:	±5KHz (Wide) ±2.5KHz (Narrow)

Spurious Emission:	At least 60dB below
Microphone Impedance:	2K Ω

Receiver	
Circuit Type:	Double-Conversion Super heterodyne (FM/AM) Single-Conversion Super heterodyne (Radio)
Intermediate Frequencies:	1st: 51.550kHz (A Band) 2nd: 450KHz
Sensitivity:	1st: 50KHz (FM Radio) 2 μ V TYP for 12dB SINAD (76-108 MHz, WFM) 0.25 μ V TYP for 12dB SINAD (336-400MHz, FM) 0.8 μ V TYP for 10dB SN (108-135.995MHz, AM) 0.2 μ V for 12dB SINAD (400-480MHz, FM) EXP 0.2 μ V for 12dB SINAD (136-173.995MHz) 0.3 μ V TYP for 12dB SINAD (480-520MHz, WFM)
Squelch Sensitivity:	0.13 μ V (144/430MHz Band)
Selectivity (Typical):	(Wide) More than 10KHZ/6dB Less than 30.KHz/60dB (Narrow) More than 6KHz/6dB Less than 20.KHz/60dB
AF Output:	8W @ 4 Ω for 10% THD (@ 13.8 V) BTL EXP SP 4W @ 4 Ω for 10% THD (@ 13.8V) Normal EXP SP
AF Output Impedance:	4-16 Ω

